

SERVICE MANUAL TECHNICAL INFORMATION

FOR SERVICE PERSONNEL ONLY

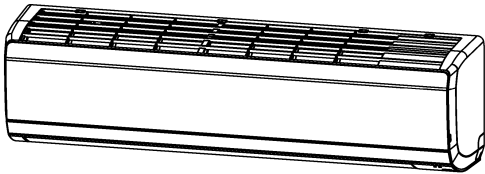

RAS-EH36PHLAE

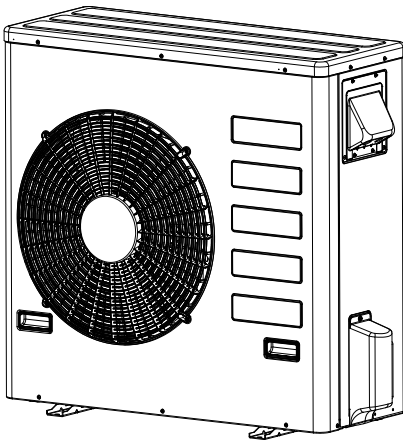

RAC-EH36WHLAE

REFER TO THE FOUNDATION MANUAL

CONTENTS

SPECIFICATIONS	6
HOW TO USE	9
CONSTRUCTION AND DIMENSIONAL DIAGRAM	38
MAIN PARTS COMPONENT	40
WIRING DIAGRAM	42
CIRCUIT DIAGRAM	44
PRINTED WIRING BOARD LOCATION DIAGRAM	47
BLOCK DIAGRAM	53
BASIC MODE	54
REFRIGERATING CYCLE DIAGRAM	64
AUTO SWING FUNCTION	65
DESCRIPTION OF MAIN CIRCUIT OPERATION	66
SERVICE CALL Q & A	93
DISASSEMBLE & ASSEMBLY PROCEDURE	101
TROUBLE SHOOTING	110
PARTS LIST AND DIAGRAM	134

SPECIFICATIONS

TYPE		(WALL TYPE)	
		INDOOR UNIT	OUTDOOR UNIT
MODEL		RAS-EH36PHLAE	RAC-EH36WHLAE
POWER SOURCE		1 PHASE 60Hz 208 - 230V	
COOLING	TOTAL INPUT	(w)	3850
	TOTAL AMPERES	(A)	18.00
	CAPACITY	(kW)	9.7
		(B.T.U./h)	33000 (7000 - 34000)
HEATING	TOTAL INPUT	(w)	4000
	TOTAL AMPERES	(A)	17.80
	CAPACITY	(kW)	10.6
		(B.T.U./h)	36000 (9000 - 37500)
DIMENSIONS inch (mm)	W		43.30
			(1100)
	H		11.81
			(300)
D		10.23	
		(260)	
NET WEIGHT		lbs(kg)	33.1 (15)
			37.40
			(950)
			37.20
			(945)
			14.57
			(370)
			189.57 (85.99)

※ After installation

SPECIFICATIONS AND PARTS ARE SUBJECT TO CHANGE FOR IMPROVEMENT

ROOM AIR CONDITIONER

INDOOR UNIT + OUTDOOR UNIT

SAFETY DURING REPAIR WORK

1. In order to disassemble and repair the unit in question, be sure to disconnect the power cord plug from the power outlet before starting the work.

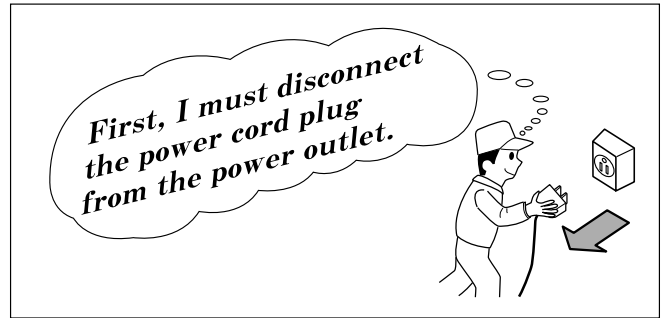

2. If it is necessary to replace any parts, they should be replaced with respective genuine parts for the unit, and the replacement must be effected in correct manner according to the instructions in the Service Manual of the unit.

If the contacts of electrical parts are defective, replace the electrical parts without trying to repair them.

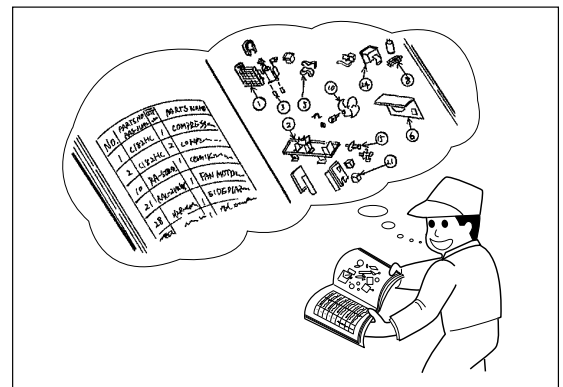

3. After completion of repairs, the initial state should be restored.
4. Lead wires should be connected and laid as in the initial state.
5. Modification of the unit by the user himself should absolutely be prohibited.

6. Tools and measuring instruments for use in repairs or inspection should be accurately calibrated in advance.
7. In installing the unit having been repaired, be careful to prevent the occurrence of any accident such as electrical shock, leak of current, or bodily injury due to the drop of any part.
8. To check the insulation of the unit, measure the insulation resistance between the power cord plug and grounding terminal of the unit. The insulation resistance should be $1M\Omega$ or more as measured by a 500V DC megger.
9. The initial location of installation such as window, floor or the other should be checked for being and safe enough to support the repaired unit again.
If it is found not so strong and safe, the unit should be installed at the initial location after reinforced or at a new location.

10. Any inflammable object must not be placed about the location of installation.

11. Check the grounding to see whether it is proper or not, and if it is found improper, connect the grounding terminal to the earth.

12. If refrigerant gas leaks during repair work, please ensure there is enough ventilation, leaked refrigerant that accumulates in stagnation, rarely causes any ignition when in contact with flame (stove, heater). However it will generate toxic fumes.

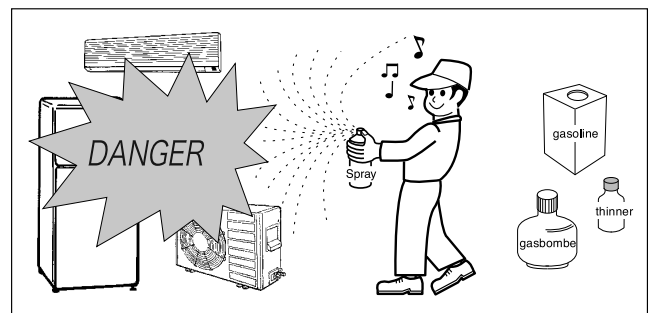

13. If refrigerant gas leaks, be sure to repair the leak(s) securely before recharge the unit. Refrigerant (R410A) is harmless. However when comes in contact with fire will generate toxic gas.

WORKING STANDARDS FOR PREVENTING BREAKAGE OF SEMICONDUCTORS

1. Scope

The standards provide for items to be generally observed in carrying and handling semiconductors in relative manufacturers during maintenance and handling thereof. (They apply the same to handling of abnormal goods such as rejected goods being returned).

2. Object parts

- (1) Micro computer
- (2) Integrated circuits (I.C.)
- (3) Field-effective transistor (F.E.T.)
- (4) P.C. boards or the like to which the parts mentioned in (1) and (2) of this paragraph are equipped.

3. Items to be observed in handling

- (1) Use a conductive container for carrying and storing of parts. (Even rejected goods should be handled in the same way).

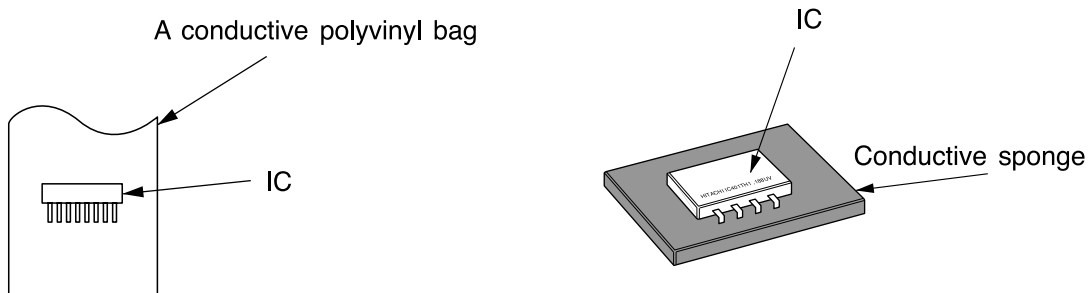

Fig. 1. Conductive container

- (2) When any part is handled uncovered (in counting, packing and the like), the handling person must always use himself as a body earth. (Make yourself a body earth by passing $1M\Omega$ earth resistance through a ring or bracelet).
- (3) Be careful not to touch the parts with your clothing when you hold a part even if a body earth is being taken.
- (4) Be sure to place a part on a metal plate with grounding.
- (5) Be careful not to fail to turn off power when you repair the printed circuit board. At the same time, try to repair the printed circuit board on a grounded metal plate.

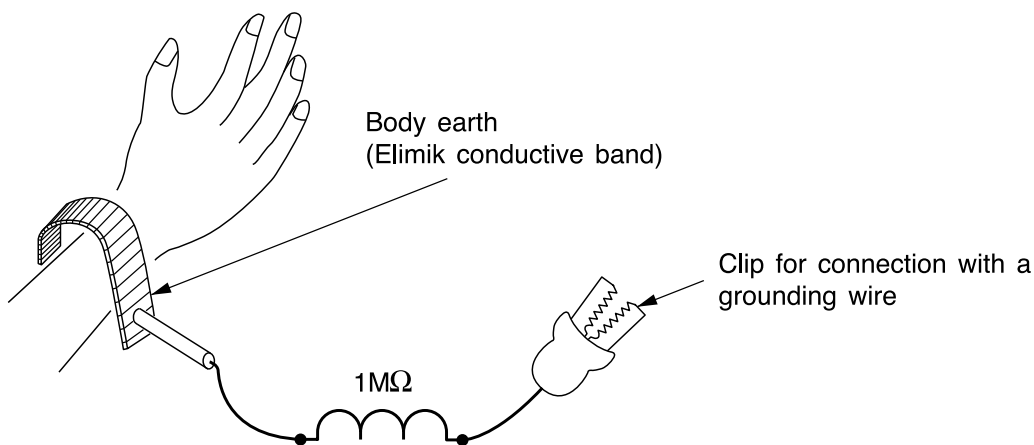

Fig. 2. Body Earth

(6) Use a three wire type soldering iron including a grounding wire.

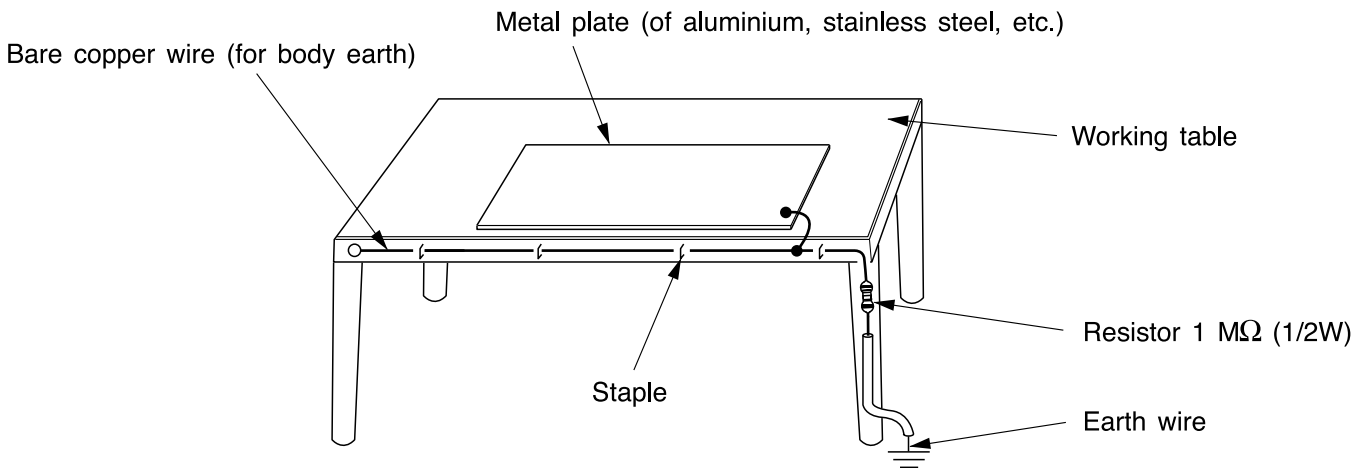

Fig. 3. Grounding of the working table

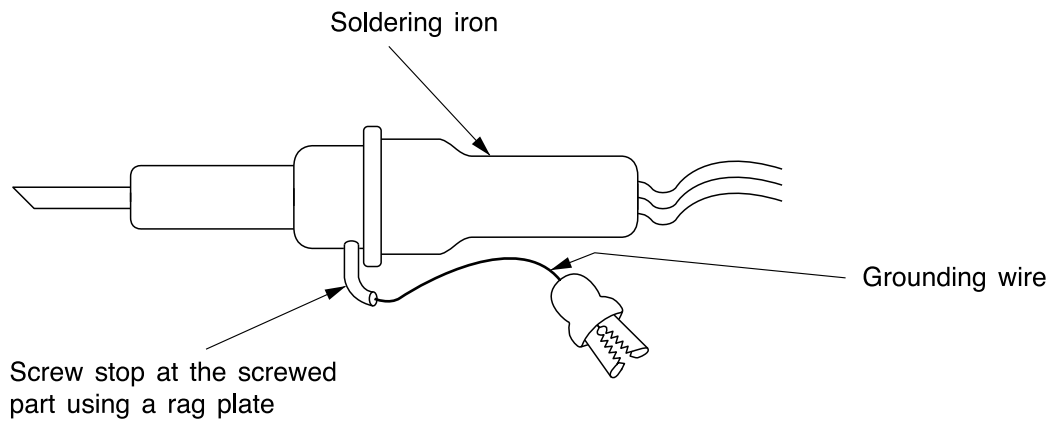

Fig. 4. Grounding a solder iron

Use a high insulation mode (100V, 10MΩ or higher) when ordinary iron is to be used.

(7) In checking circuits for maintenance, inspection or some others, be careful not to have the test probes of the measuring instrument short circuit a load circuit or the like.

 **CAUTION**

1. Slight flowing noise of refrigerant in the refrigerating cycle is expected to be heard occasionally in quiet or stop operation and it is normal.
2. When it thunders near by, it is recommend to stop the operation and to disconnect the power cord plug from the power outlet for safety.
3. The room air conditioner does not start automatically after recovery of the electric power failure for preventing fuse blowing. Re-press COOLING button after 3 minutes from when unit stopped.
4. If the room air conditioner is stopped by adjusting thermostat, or missoperation, and re-start in a moment, there is occasion that the cooling operation does not start for 3 minutes, it is not abnormal and this is the result of the operation of IC delay circuit. This IC delay circuit ensures that there is no danger of blowing fuse or damaging parts even if operation is restarted accidentally.
5. This room air conditioner should not be used at the cooling operation when the outside temperature is below $-18^{\circ}\text{C}(-0.4^{\circ}\text{F})$.
6. This room air conditioner (the reverse cycle) should not be used when the outside temperature is below $-18^{\circ}\text{C}(-0.4^{\circ}\text{F})$
If the reverse cycle is used under this condition, the outside heat exchanger is frosted and efficiency falls.
7. When the outside heat exchanger is frosted, the frost is melted by operating the hot gas system, it is not trouble that at this time fan stops and the vapour may rise from the outside heat exchanger.

SPECIFICATIONS

MODEL		RAS-EH36PHLAE	RAC-EH36WHLAE
FAN MOTOR		38W	120W
FAN MOTOR CAPACITOR		NO	NO
FAN MOTOR PROTECTOR		NO	NO
COMPRESSOR		NO	ATL253UDPC9AQ
COMPRESSOR MOTOR CAPACITOR		NO	NO
OVERLOAD PROTECTOR		NO	YES
OVERHEAT PROTECTOR		NO	YES
FUSE (for MICROPROCESSOR)		NO	5.0A
POWER RELAY		NO	G4A
POWER SWITCH		NO	NO
TEMPORARY SWITCH		YES	NO
SERVICE SWITCH		NO	YES
TRANSFORMER		NO	NO
VARISTOR		NO	ERZV9V431
NOISE SUPPRESSOR		NO	YES
THERMOSTAT		YES(IC)	YES(IC)
REMOTE CONTROL SWITCH (LIQUID CRYSTAL)		YES	NO
REFRIGERANT CHARGING VOLUME (Refrigerant R410A)	UNIT	-----	5.84 ib (2.65kg)
	PIPES (MAX. 98.5ft (30m))	-----	Additional 0.1oz/ft(10g/m) after 4.92ft(15m) length

In case the pipe length is more than 49.2ft(15m), add refrigerant R410A at 10gram per every meter ex ceeds.

INDOOR MODEL : RAS-EH36PHLAE

Direction of Piping

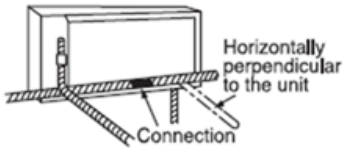

Horizontally perpendicular to the unit

Connection

There are 6 directions allowed, namely, horizontally perpendicular to the unit, vertically down from right, horizontally out from right, horizontally out to left, horizontally out to right, vertically down from left.

Don't form the piping downward at the left of the unit.

Figure showing the Installation of Indoor

CAUTION

- The difference in height between the indoor and outdoor unit should be kept max. 49.21ft(15m).
- The connecting pipe, no matter big or small, should all be insulated with insulation pipe and then wrapped with plastic tape. (The insulator will deteriorate if it is not wrapped with tape).

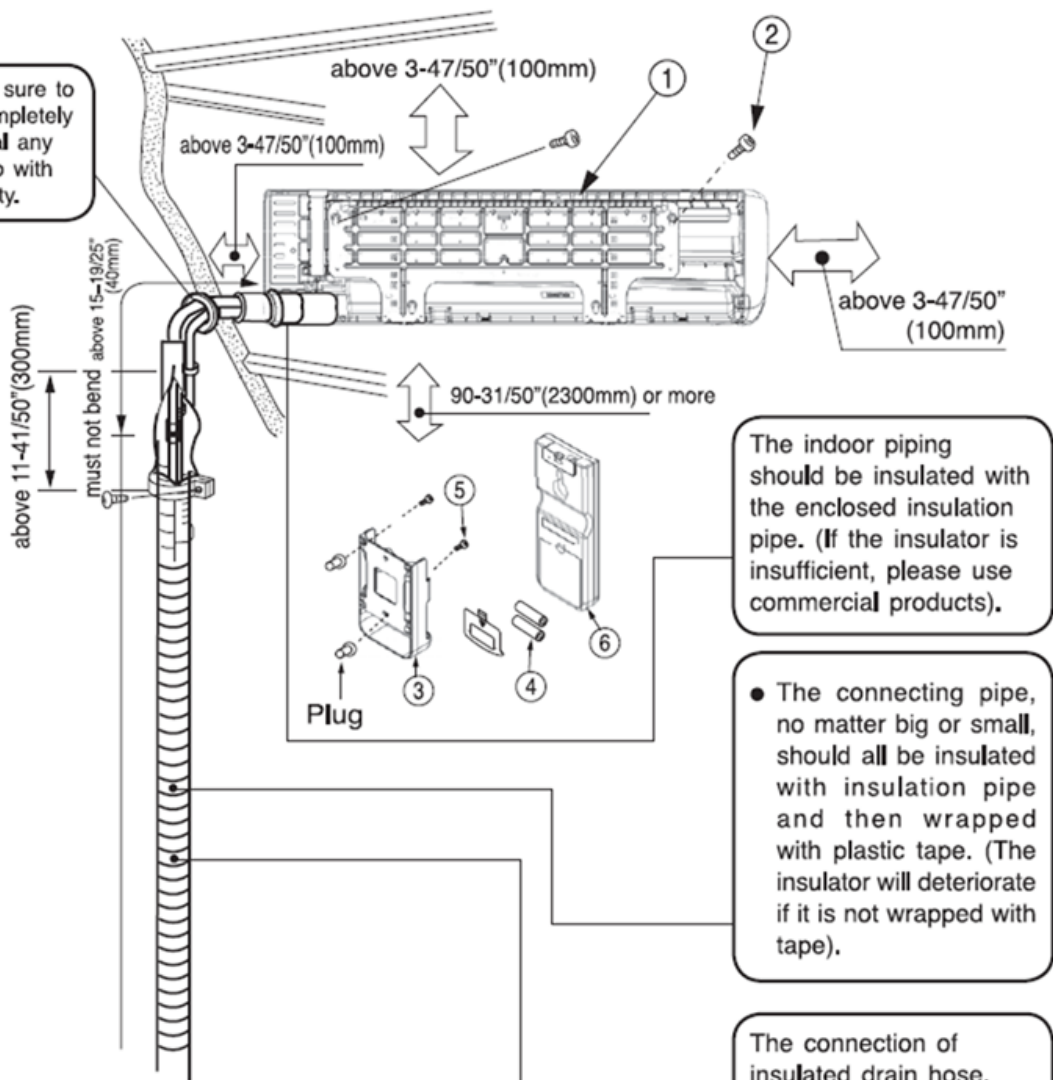

Be sure to completely seal any gap with putty.

above 3-47/50" (100mm)

above 3-47/50" (100mm)

above 3-47/50" (100mm)

above 3-47/50" (100mm)

above 11-41/50" (300mm)

must not bend above 15-19/25" (40mm)

90-31/50" (2300mm) or more

Plug

1

2

3

4

5

6

The indoor piping should be insulated with the enclosed insulation pipe. (If the insulator is insufficient, please use commercial products).

- The connecting pipe, no matter big or small, should all be insulated with insulation pipe and then wrapped with plastic tape. (The insulator will deteriorate if it is not wrapped with tape).

The connection of insulated drain hose.

inner diameter ϕ 63/100" (16mm)

Please use insulated drain hose for the indoor piping (commercial product).

OUTDOOR MODEL : RAC-EH36WHLAE

⚠ CAUTION

- A brazed, welded or mechanical connection shall be made before opening the valves to permit refrigerant to flow between the refrigerating system parts. A vacuum valve shall be provided to evacuate the interconnecting pipe and/or any uncharged refrigerating system.
- Mechanical connectors used indoors shall comply with ISO 14903. When mechanical connectors are reused indoors, sealing parts shall be renewed. When flare joints are reused indoors, the flare part shall be re-fabricated.
- Refrigerant tubing shall be protected or enclosed to avoid damage.

⚠ WARNING

- Flare connection only at outside of building

⚠ CAUTION

- Installation of pipe length less than minimum pipe length requirement 16-13/32ft(5m) may generate an abnormal sound.

⚠ CAUTION

- The difference in height between the indoor and outdoor unit should be kept max. 65-39/64ft(20m).
- The connecting pipe, no matter big or small, should all be insulated with insulation pipe and then wrapped with plastic tape. (The insulator will deteriorate if it is not wrapped with tape).

Refrigerant piping must be protected from physical damage. Install a plastic cover or equivalent.

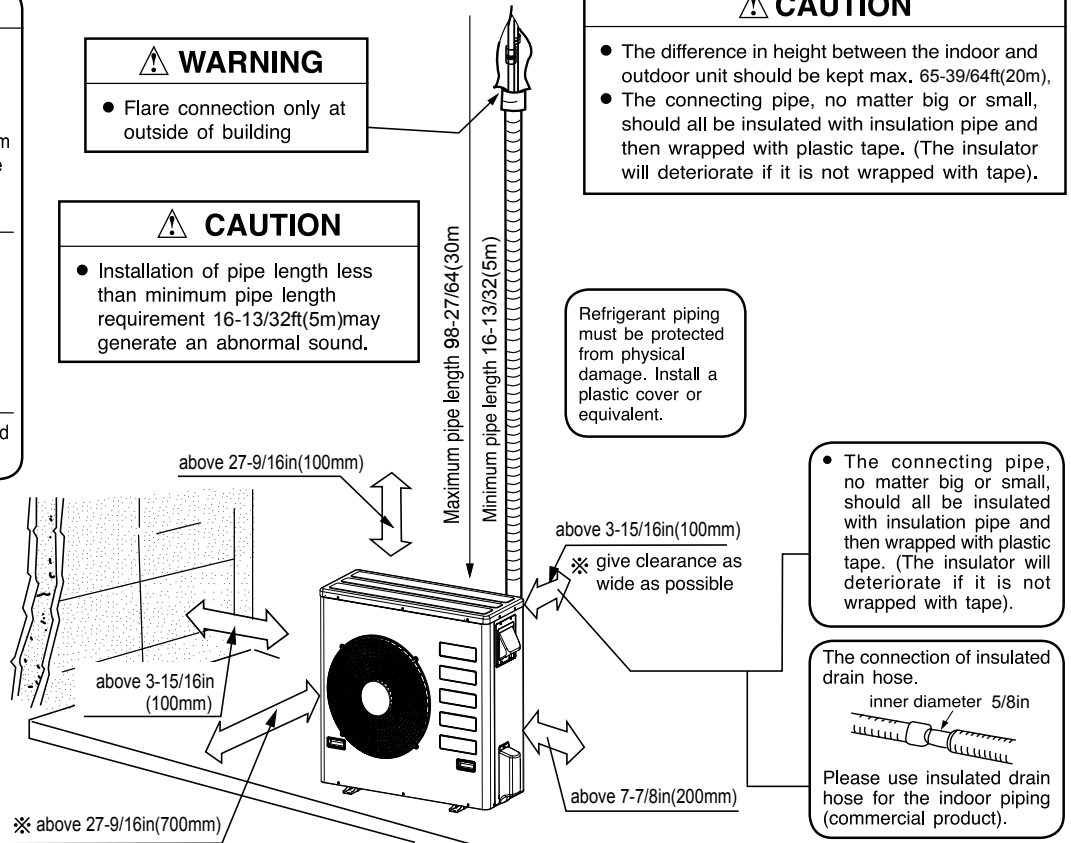

- The connecting pipe, no matter big or small, should all be insulated with insulation pipe and then wrapped with plastic tape. (The insulator will deteriorate if it is not wrapped with tape).

The connection of insulated drain hose.
inner diameter 5/8in
Please use insulated drain hose for the indoor piping (commercial product).

Important Notice

- Johnson Controls-Hitachi Air Conditioning North America LLC pursues a policy of continuing improvement in design and performance in its products. As such, Johnson Controls-Hitachi Air Conditioning North America LLC reserves the right to make changes at any time without prior notice.
- Johnson Controls-Hitachi Air Conditioning North America LLC cannot anticipate every possible circumstance that might involve a potential hazard.
- This inverter air conditioning unit is designed for standard air conditioning applications only. Do not use this unit for anything other than the purposes for which it was intended.
- The installer and system specialist shall safeguard against leakage in accordance with local codes. The following standards may be applicable, if local regulations are not available. International Organization for Standardization: (ISO 5149 or European Standard, EN 378). No part of this manual may be reproduced in any way without the expressed written consent of Johnson Controls-Hitachi Air Conditioning North America LLC.
- This air conditioning unit will be operated and serviced in the United States of America and comes with a full complement of the appropriate Safety, Danger, and Caution, Warnings.
- If you have questions, please contact your distributor or contractor.
- This manual provides common descriptions, basic and advanced information to maintain and service this air conditioning unit which you operate as well for other models.
- This air conditioning unit has been designed for a specific temperature range. For optimum performance and long life, operate this unit within the range limits.
- This manual should be considered as a permanent part of the air conditioning equipment and should remain with the air conditioning equipment.

Product Inspection upon Arrival

1. Upon receiving this product, inspect it for any damages incurred in transit. Claims for damage, either apparent or concealed, should be filed immediately with the shipping company.
2. Check the model number, electrical characteristics (power supply, voltage, and frequency rating), and any accessories to determine if they agree with the purchase order.
3. The standard utilization for this unit is explained in these instructions. Use of this equipment for purposes other than what it designed for is not recommended.
4. Please contact your local agent or contractor as any issues involving installation, performance, or maintenance arise. Liability does not cover defects originating from unauthorized modifications performed by a customer without the written consent of Johnson Controls-Hitachi Air Conditioning North America LLC. Performing any mechanical alterations on this product without the consent of the manufacturer will render your warranty null and void.

California Proposition 65



Proposition 65: This product contains chemicals known to the state of California to cause cancer, birth defects, and other reproductive harm. For more information, go to www.P65Warnings.ca.gov



SAFETY PRECAUTION

- Please read the “Safety Precaution” carefully before operating the unit to ensure correct usage of the unit.
- To prevent personal injury or property damage, read this section carefully before you use this product, and be sure to comply with the following safety precautions. Incorrect operation due to failure to follow the instructions may cause harm or damage, the seriousness of which is classified as follows:

⚠ WARNING

This mark warns of death or serious injury.

⚠ CAUTION

This mark warns of injury or damage to property.

 This mark denotes an action that is PROHIBITED.

 This mark denotes an action that is COMPULSORY.

- Please keep this manual after reading.

WARNING

⚠
 W
 A
 R
 N
 I
 N
 G

- Please use ground wiring.
Connect the power supply and the ground wiring to the terminals in the electrical box.
Ground wiring must be securely connected.
Use a GFCI (Ground Fault Circuit Interrupter).
Failure to use a GFCI can result in electric shock or fire.
- Be sure to use the specified piping set for R410A. Otherwise, this may result in broken copper pipes or faults.
- Should abnormal situation arises (like burning smell), please stop operating the unit and turn off the circuit breaker. Contact your agent. Fault, short circuit or fire may occur if you continue to operate the unit under abnormal situation.
- Please contact your agent for maintenance. Improper self maintenance may cause electric shock and fire.
- Please contact your agent if you need to remove and reinstall the unit. Electric shock or fire may occur if you remove and reinstall the unit yourself improperly.
- If the supply cord is damaged, it must be replaced by the special cord obtainable at authorized service/parts centers.
- Do not insert a finger, a rod or other objects into the air outlet or inlet. As the fan is rotating at a high speed, it will cause injury. Before cleaning, be sure to stop the operation and turn the breaker OFF.
- Do not use any conductor as fuse wire, this could cause fatal accident.
- During thunder storm, disconnect and turn off the circuit breaker.

- Do not reconstruct the unit.
Water leakage, fault, short circuit or fire may occur if you reconstruct the unit by yourself.
- Please ask your sales agent or qualified technician for the installation of your unit. Water leakage, short circuit or fire may occur if you install the unit by yourself.
- Spray cans and other combustibles should not be located within a meter 3.28ft(1m) of the air outlets of both indoor and outdoor units.
As a spray can's internal pressure can be increased by hot air, a rupture may result.



CAUTION

⚠
 C
 A
 U
 T
 I
 O
 N

- A circuit breaker should be installed depending on the mounting site of the unit. Without a circuit breaker, the danger of electric shock exists.
- Do not install near location where there is flammable gas. The outdoor unit may catch fire if flammable gas leaks around it.
- Please ensure a smooth flow of condensate when installing the condensate hose.
- Do not install the indoor unit in a machine shop or kitchen where vapor from oil or its mist flows to the indoor unit. The oil will deposit on the heat exchanger, thereby reducing the indoor unit performance and may deform and in the worst case, break the plastic parts of the indoor unit.

PRECAUTIONS DURING OPERATION

- The product shall be operated under the manufacturer specification and not for any other intended use.



- Do not attempt to operate the unit with wet hands, this could cause fatal accident.

- When operating the unit with burning equipments, regularly ventilate the room to avoid insufficient oxygen.



- Do not direct the cool air coming out from the air-conditioner panel to face household heating apparatus as this may affect the working of apparatus such as the electric kettle, oven etc.

- Please ensure that outdoor mounting frame is always stable, firm and without defect. If not, the outdoor unit may collapse and cause danger.



- Do not splash or direct water to the body of the unit when cleaning it as this may cause short circuit.

- Do not use any aerosol or hair sprays near the indoor unit. This chemical can adhere on heat exchanger fin and block the flow of condensate to the condensate pan. Condensate might drip on the fan and cause droplets to occasionally drip from the indoor unit.



C
A
U
T
I
O
N



- Please switch off the unit and turn off the circuit breaker during cleaning, the high-speed fan inside the unit may cause danger.

- Turn off the circuit breaker if the unit is not to be operated for a long period.



- Do not climb on the outdoor unit or put objects on it.

- Do not put water container (like vase) on the indoor unit to avoid water dripping into the unit. Dripping water will damage the insulator inside the unit and cause a short circuit.



- Do not place plants directly under the air flow as it is bad for the plants.

- When operating the unit with the door and windows opened, (the room humidity is always above 80%) and with the louver facing down or moving automatically for a long period of time, condensate will condense on the louver and drips down occasionally. This will wet your furniture. Therefore, do not operate under such condition for a long time.

- If the amount of heat in the room is above the cooling or heating capability of the unit (for example: more people entering the room, using heating equipments and etc.), the preset room temperature cannot be achieved.

- This appliance can be used by children aged from 8 years and above and persons with reduced physical, sensory or mental capabilities or lack of experience and knowledge if they have been given supervision or instruction concerning use of the appliance in a safe way and understand the hazards involved. Children shall not play with the appliance. Cleaning and user maintenance shall not be made by children without supervision.

OPERATING RANGE

Operation mode	Cooling / Dehumidifying	Heating
Outdoor temperature	-0.4°F to 114.8°F(-18°C to 46°C)	-0.4°F to 75.2°F(-18°C to 24°C)

NAMES AND FUNCTIONS OF EACH PART

INDOOR UNIT

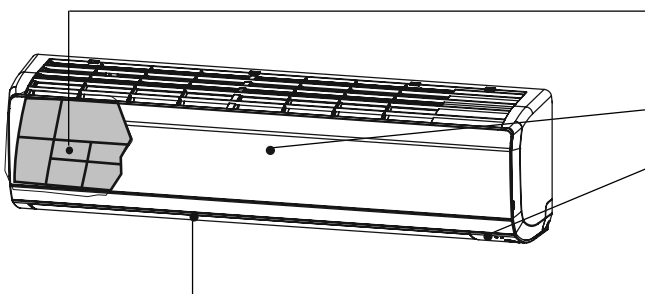

Pre-filter
To prevent dust from coming into the indoor unit.

Front panel

Indoor unit indicators
LED light shows the operating mode.

Horizontal deflector • Vertical deflector (Air Outlet)

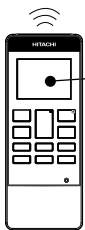

Remote controller
Send out operation signal to the indoor unit. So as to operate the whole unit. Please refer to the Remote Manual provided for functions and operation details.

OUTDOOR UNIT

Air outlet

When “heating” operation is performed, cool air blows and when “cooling” or “dehumidifying” operation is performed, warm air blows.

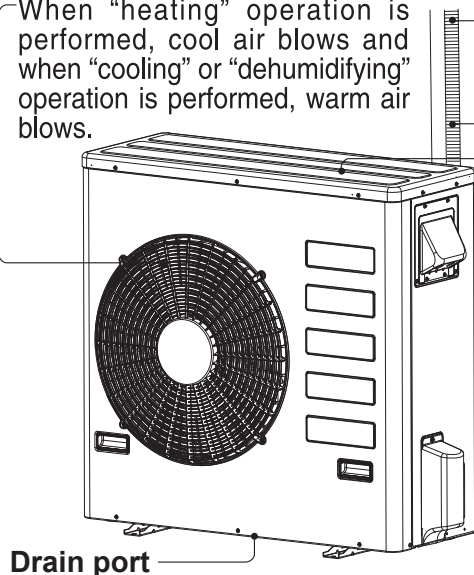

Drain hose
Drains the dehumidified water from the indoor unit to the outdoor during “cooling” or “dehumidifying” operation.

Piping and Wiring
Air inlets (Rear and left sides)

Drain port

CAUTION

- When heating operation, drain or defrosted water flows out from outdoor unit. Don't close drain outlet portion in chilly area so as not to freeze these.

MODEL NAME AND DIMENSIONS

MODEL	WIDTH in(mm)	HEIGHT in(mm)	DEPTH in(mm)
RAS-EH36PHLAE	43.31”(1100)	11.81” (300)	10.24” (260)
RAC-EH36WHLAE	37.40”(950)	37.20” (945)	14.57” (370)

INDOOR UNIT INDICATORS

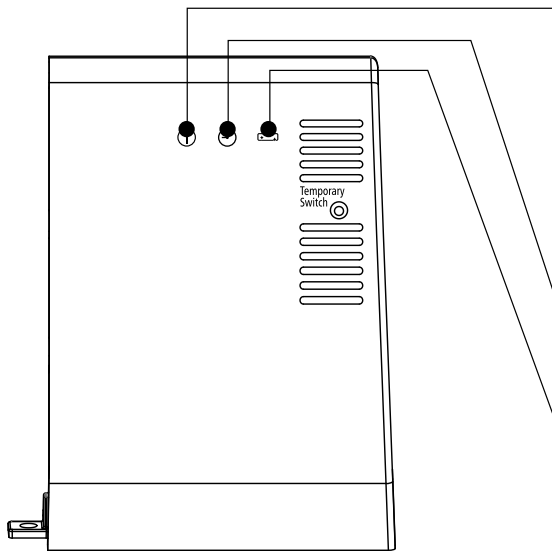

OPERATION LED

This LED lights during operation.
The OPERATION LED flashes/dimming in the following cases during heating.

(1) 1) During preheating

For about 2–3 minutes after starting up.

(2) 2) During defrosting

Defrosting is performed about once every one hour when frost forms on the heat exchanger of the outdoor unit, for 5–10 minutes each time.

TIMER LED

This LED lights up when the timer is working.

FROST WASH LED

This LED lights when the Frost Wash function is in operation. If the auto Frost Wash function is canceled and operation is stopped, when the device is operated for a total of about 42 hours, the Frost Wash LED blinks to indicate that it is time to operate the manual Frost Wash function.
(not applicable for Multi split connection)

OPERATION INDICATOR

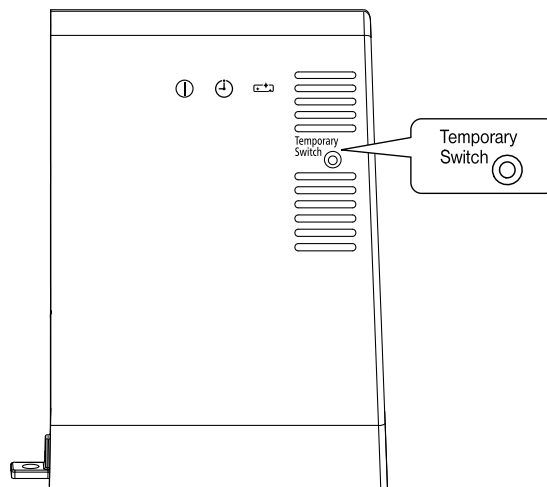

TEMPORARY SWITCH

Use this switch to start and stop when the remote controller does not work. [Use non-conductor stick (example toothpick)]

- By pressing the temporary switch, the operation is done in automatic operation mode.
- When the operation is done using the temporary switch after the power source is turned off and turn on again, the operation is done in automatic mode.

THE IDEAL WAYS OF OPERATION

Suitable Room Temperature

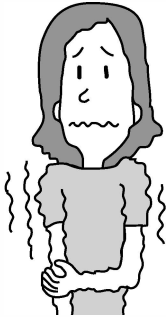

⚠ Warning

Freezing temperature is bad for health and a waste of electric power.

Install curtain or blinds

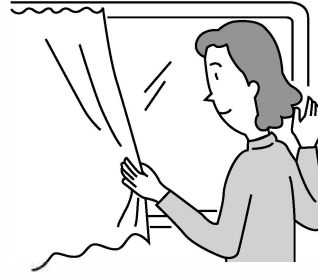

It is possible to reduce heat entering the room through windows.

Ventilation

⚠ Caution

Do not close the room for a long period of time. Occasionally open the door and windows to allow the entrance of fresh air.



Effective Usage Of Timer

At night, please use the "OFF or ON timer or SLEEP timer operation mode", together with your wake up time in the morning. This will enable you to enjoy a comfortable room temperature. Please use the timer effectively.

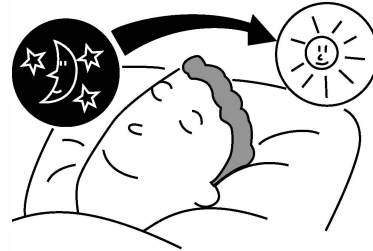

Do Not Forget To Clean The Pre-Filter

Dusty air filter will reduce the air volume and the cooling efficiency. To prevent from wasting electric energy, please clean the filter every 2 weeks.

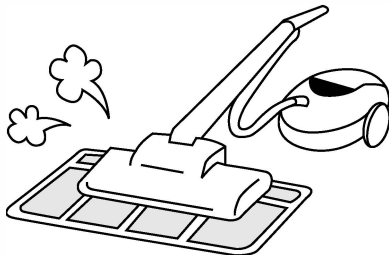

Please Adjust Suitable Temperature For Baby And Children

Please pay attention to the room temperature and air flow direction when operating the unit for baby, children and old folks who have difficulty in movement.

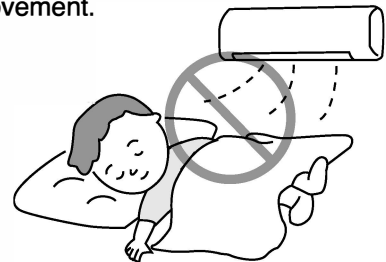

FOR USER'S INFORMATION

The Air Conditioner And The Heat Source In The Room

⚠ Caution

If the amount of heat in the room is above the cooling capability of the air conditioner (for example: more people entering the room, using heating equipments and etc.), the preset room temperature cannot be achieved.

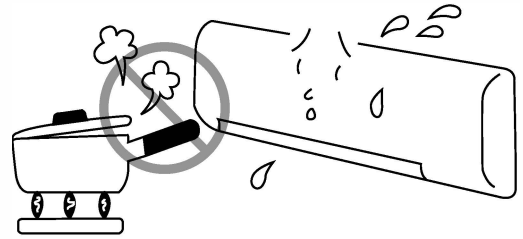

Not Operating For A Long Time

When the indoor unit is not to be used for a long period of time, please switch off the power from the main unit. If the power from main unit remains "ON", the indoor unit still consumes about 3W in the operation control circuit even if it is in "OFF" mode.

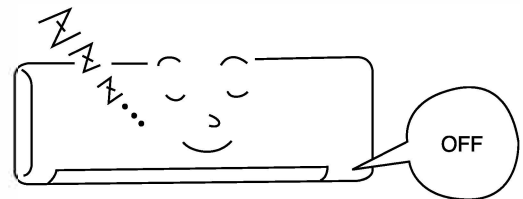

When Lightning Occurs

⚠ Warning

To protect the whole unit during lightning, please stop operating the unit.

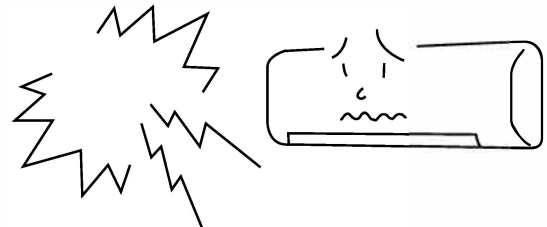

Interference From Electrical Products

⚠ Caution

To avoid noise interference, please place the indoor unit and its remote controller at least 3.28ft (1m) away from electrical products.

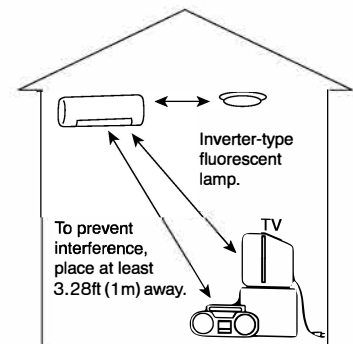

ATTACHING THE AIR PURIFYING FILTERS

1 Open the front panel

- Pull up the front panel by holding it at both sides with both hands.

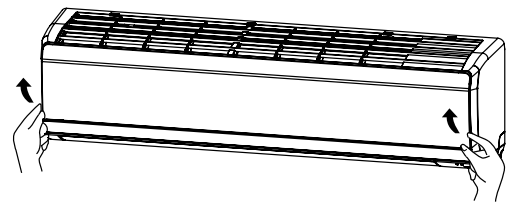

2 Remove the Prefilter

- Push upward to release the clasps and pull out the Pre-filter.

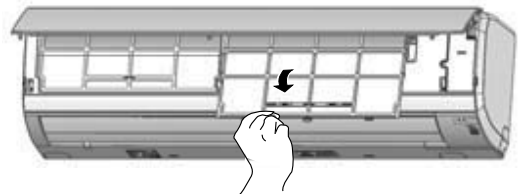

3

Attaching the air purifying filters

- Attach the air purifying filters to the frame by gently compress its both sides and release after insertion to Pre-filter frame.

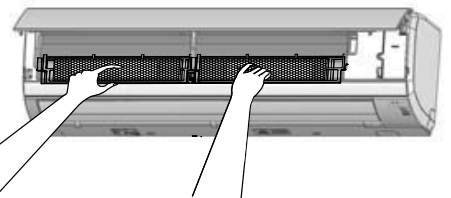
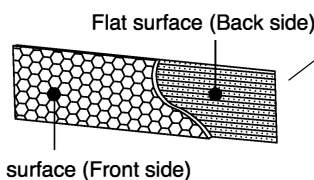

CAUTION

Do not bend the air purifying filter as it may cause damage to the structure.

Please do not smell direct from source of filter.

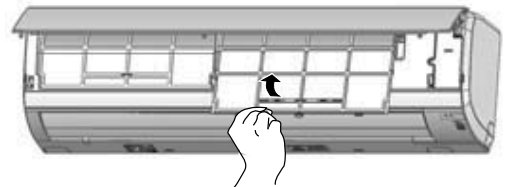

4

Attach the Prefilters

- Attach the Pre-filters by ensuring that the surface written "FRONT" is facing front.
- After attaching the Pre-filters, push the front panel at three arrow portions as shown in figure and close it.

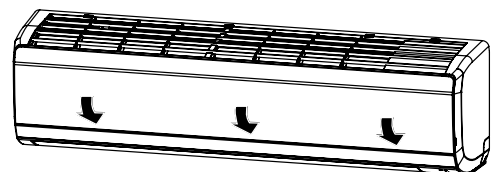

NOTE

- In case of removing the air purifying filters, please follow the above procedures.
- The cooling capacity is slightly weakened and the cooling speed becomes slower when the air purifying filters are used. So, set the fan speed to "HIGH" when using it in this condition.
- Air purifying filters are not washable. It is recommended to use vacuum to clean it. It can be use for 1 year time. Type number for this air purifying filter is <SPX-CFH22AC25>. Please use this number for ordering when you want to renew it. Part can be purchased from an authorized service parts centers.



MAINTENANCE

⚠ CAUTION

Cleaning and maintenance must be carried out only by qualified service personnel. Before cleaning, stop operation and switch off the power supply.

1. PRE-FILTER

Clean the Pre-filter, as it removes dust inside the room. In case the Pre-filter is full of dust, the air flow will decrease and the cooling capacity will be reduced. Further, noise may occur. Be sure to clean the Pre-filter following the procedure below.

PROCEDURE

- 1 Open the front panel and remove the Pre-filter
 - Gently lift and remove the air purifying filters from the air purifying filter frame.

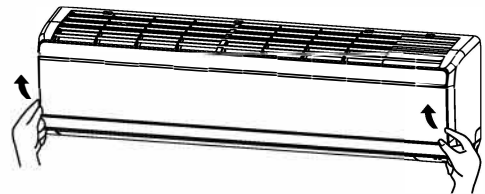

- 2 Vacuum dust from the Pre-filter and air purifying filter using vacuum cleaner. If there is too much dust, rinse under running tap water and gently brush it with soft bristle brush. Allow filters to dry in shade.

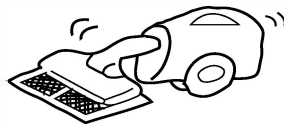
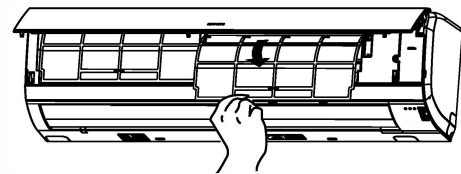

- 3
 - Re-insert the air purifying filter to the filter frame. Set the Pre-filter with "FRONT" mark facing front, and slot them into the original state.
 - After attaching the Pre-filters, push the front panel at three arrow portions as shown in figure and close it.

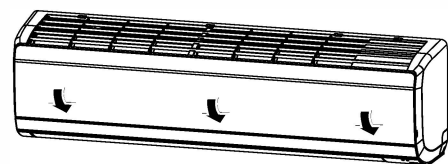

NOTE:

- Air purifying filter should be cleaned every month or sooner if noticeable loading occurs. When used overtime, it may lose its deodorizing function. For maximum performance, it is recommended to replace it every 1 year depending on application requirements.

⚠ CAUTION

- Do not operate the air conditioner without Pre-filter. Dust may enter the air conditioner and fault may occur.
- Do not wash with hot water at more than 104°F(40°C). The Pre-filters may shrink.
- When washing it, shake off moisture completely and dry it in the shade; do not expose it directly to the sun. The Pre-filters may shrink.
- Do not use detergent on the Pre-filter as some detergent may deteriorate the Pre-filter electrostatic performance.

2. CLEANING OF FRONT PANEL

- Remove the front panel and wash with clean water. Wash it with a soft sponge. After using neutral detergent, wash thoroughly with clean water.
- When front panel is not removed, wipe it with a soft dry cloth. Wipe the remote controller thoroughly with a soft dry cloth.
- Wipe the water thoroughly. If water remains at indicators or signal receiver of indoor unit, it causes trouble.

Method of removing the front panel.

Be sure to hold the front panel with both hands to detach and attach it.



Removing the Front Panel

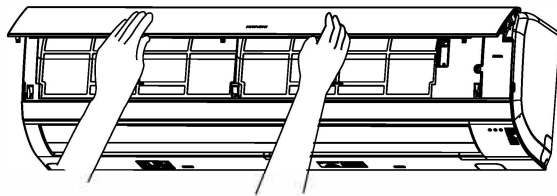

- When the front panel is fully opened with both hands, push the right arm to the outside to release it, and while closing the front panel slightly, pull it out forward.

Attaching the Front Panel

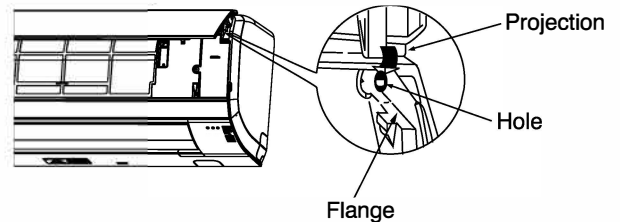

- Move the projections of the left and right arms into the Flanges in the unit and securely insert them into the holes.

CAUTION

- Never use hot water (above 104°F(40°C)), benzene, gasoline, acid, thinner or a brush, because they will damage the plastic surface and the coating.



⚠ CAUTION



- Please use ground wiring.
Do not place the ground wiring near water or gas pipes, lightning-conductor, or the ground wiring of telephone. Improper installation of ground wiring may cause electric shock.
- A circuit breaker should be installed depending on the mounting site of the unit. Without a circuit breaker, the danger of electric shock exists.

IMPORTANT

The wires in this mains lead are coloured in accordance with the following code:

- Green-and-yellow : Earth/Ground
- White : Neutral
- Black : Line

As the colours of the wires in the mains lead of this appliance may not correspond with the coloured markings identifying the terminals in your plug, proceed as follows:

The wire which is coloured green-and-yellow must be connected to the terminal in the plug which is marked with the letter E or by the earth symbol (⊕) or coloured green or green-and-yellow.

The wire which is coloured white must be connected to the terminal which is marked with the letter N or coloured black.

The wire which is coloured black must be connected to the terminal which is marked with the letter L or coloured red.

NOTE

If the supply cord is damaged, it must be replaced with the new cord obtainable at authorized service parts centers.

⚠ CAUTION

Cleaning and maintenance must be carried out only by qualified service personnel. Before cleaning, stop operation and switch off the power supply.



REGULAR INSPECTION

PLEASE CHECK THE FOLLOWING POINTS BY QUALIFIED SERVICE PERSONNEL EITHER EVERY HALF YEARLY OR YEARLY. CONTACT YOUR SALES AGENT OR SERVICE SHOP.

1		Is the ground wiring disconnected or broken?
2		Is the mounting frame seriously affected by rust and is the outdoor unit tilted or unstable?

AFTER SALE SERVICE AND WARRANTY

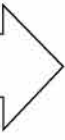
WHEN ASKING FOR SERVICE, CHECK THE FOLLOWING POINTS.

CONDITION	CHECK THE FOLLOWING POINTS
<p>If the remote controller is not transmitting a signal. (Remote controller display is dim or blank.)</p> 	<ul style="list-style-type: none"> ● Do the batteries need replacement? ● Is the polarity of the inserted batteries correct?
<p>When it does not operate</p> 	<ul style="list-style-type: none"> ● Is the fuse blown? ● Is the power supply in normal condition? ● Is the circuit breaker "ON"? ● Is the setting of operation mode different from other indoor units?
<p>When it does not cool well When it does not heat well</p> 	<ul style="list-style-type: none"> ● Is the pre-filter blocked with dust? ● Does sunlight fall directly on the outdoor unit? ● Is the airflow of the outdoor unit obstructed? ● Are the doors or windows opened, or is there any source of heat in the room? ● Is the set temperature suitable? ● Are the air inlets or air outlets of indoor and outdoor units blocked? ● Is the fan speed "LOW" or "SILENT"?



Notes

- In quiet operation or stopping the operation, the following phenomena may occasionally occur, but they are not abnormal for the operation.
 - (1) Slight flowing noise of refrigerant in the refrigerating cycle.
 - (2) Slight rubbing noise from the fan casing which is cooled and then gradually warmed as operation stops.
- The odor will possibly be emitted from the room air conditioner because the various odor, emitted by smoke, foodstuffs, cosmetics and so on, sticks to it. So the pre-filter and the evaporator regularly must be cleaned to reduce the odor.

- Please contact your sales agent immediately if the air conditioner still fails to operate normally after the above inspections. Inform your agent of the model of your unit, production number, date of installation. Please also inform him regarding the fault.
- Power supply shall be connected at the rated voltage, otherwise the unit will be broken or could not reach the specified capacity.

NOTE:

- If the supply cord is damaged, it must be replaced with the new cord obtainable at authorized service parts centers.

PREPARATION BEFORE OPERATION

When using the remote controller, if there is no response from the air conditioning unit and/or the display has faded and dimmed, the batteries in the remote control need to be removed and replaced with a new set.

■ To set the batteries

1. Slide the cover to take it off.
2. Set two dry batteries type AAA/LR03 (alkaline).
The batteries must be placed in the position of “+” and “-” polar.
3. Reinstall the battery cover.
4. Press Reset button.

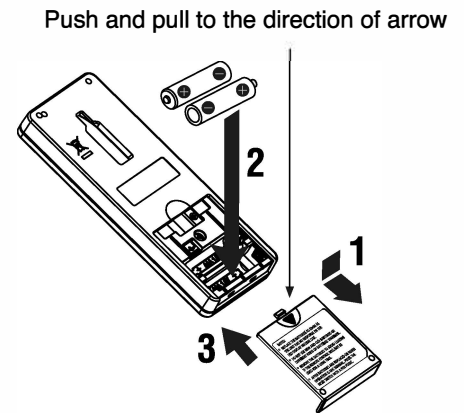

■ To mount the remote controller holder to the wall

1. Choose a place from where the signals can reach the unit.
2. Mount the remote controller holder to a wall, a pillar or similar location with the provided screws.
3. Place the remote controller in the remote controller holder.

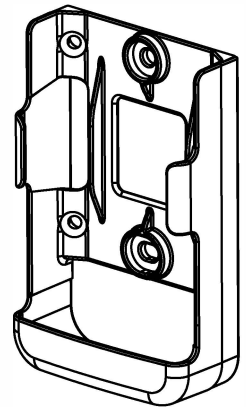

NOTES

If you replace the batteries, or after pressing 'Reset' button, the temperature display will return to °F. Follow 'Temperature Switching' instruction to change to °C.

▲ CAUTION

1. Do not mix up new and old batteries or different kind of batteries together.
2. Take out the batteries when you do not use the remote controller for 2 or 3 months.
3. Use high quality and high performance AAA batteries to avoid short operating life and electrolytes leakage.
4. After batteries are replaced or when an operation is abnormal, press 'Reset' button using a pen point.

NAMES AND FUNCTIONS OF REMOTE CONTROLLER

This remote controller controls the operation and timer setting of the room air conditioner. The operating range of the remote control from the indoor unit is 23feet (approx. 7m). If inverter lamp is used, the range may become shorter.

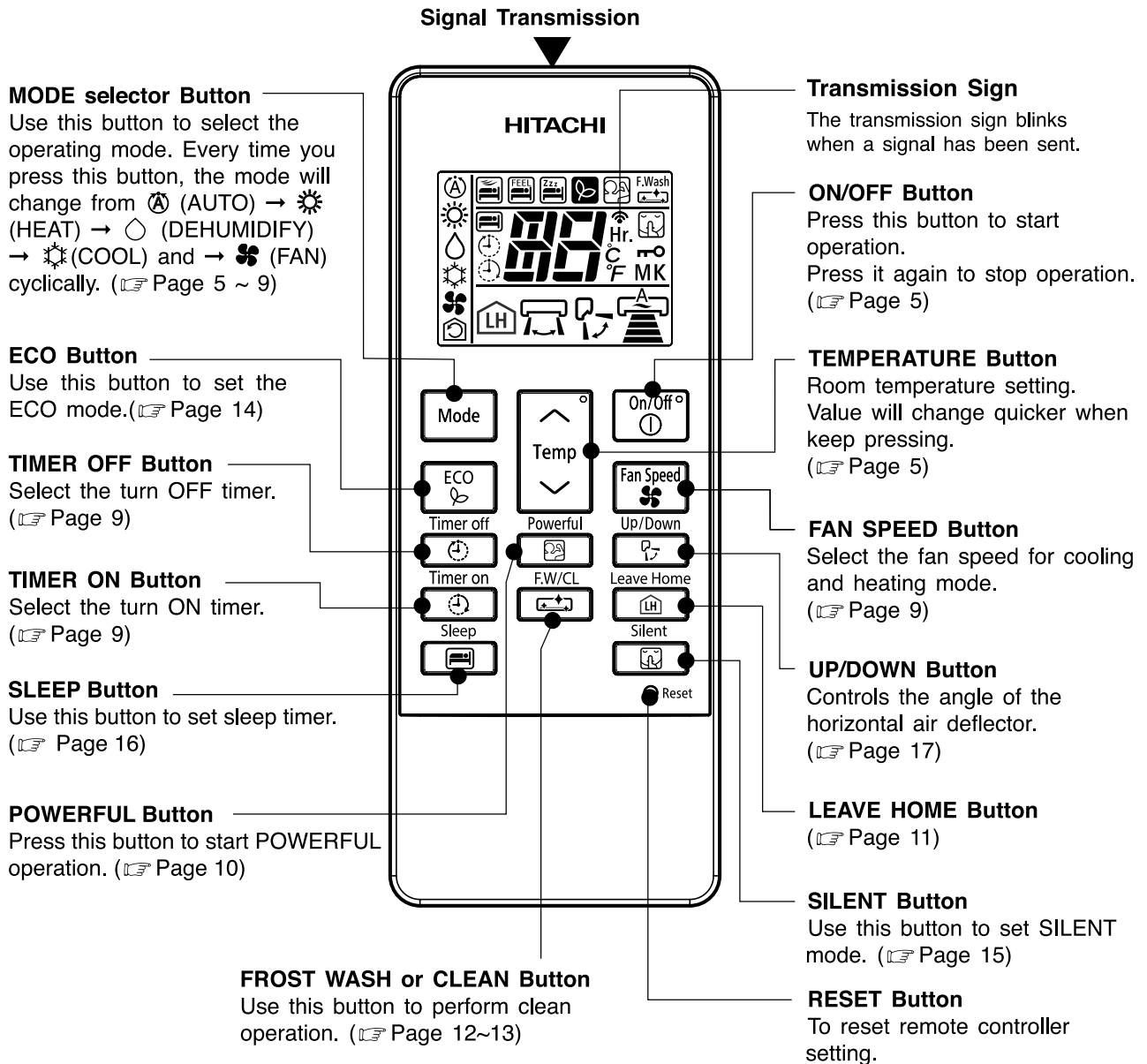

Precautions for Use

- Do not place the remote controller in the following places.
 - Under direct sunlight.
 - In the vicinity of a heater.
- Handle the remote controller carefully. Do not drop it on the floor, and protect it from water.
- Once the outdoor unit stops, it will not restart for about 3 minutes (unless you turn the power switch off and on or unplug the power cord and plug it in again). This is to protect the room air conditioner and does not indicate a failure.
- If you press the Mode button during operation, the room air conditioner may stop for about 3 minutes for protection.



Temperature Switching

The default temperature display for this model is Fahrenheit (°F).

A To switch the temperature display from Celsius to Fahrenheit

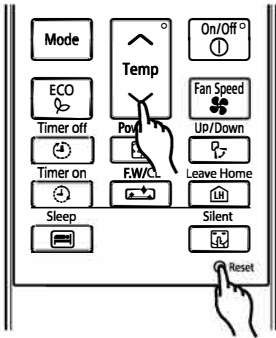
1 Press and hold  Reset +  button for 3s.



2 Release  Reset button while pressing  until LCD shows Full Segment display.

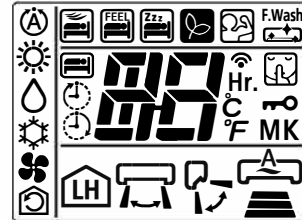

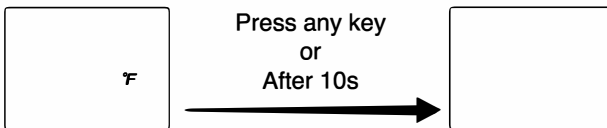

3 °F sign appears on the screen. The temperature display has switched to Fahrenheit.

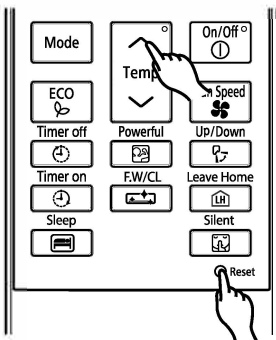

B To switch the temperature display from Fahrenheit to Celsius

1 Press and hold  Reset +  button for 3s.



2 Release  Reset button while pressing  until LCD shows Full Segment display.

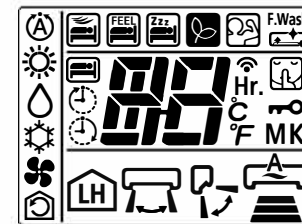

3 °C sign appears on the screen. The temperature display has switched to Celsius.

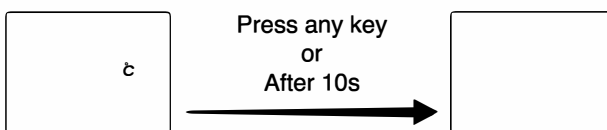

NOTE

- Temperature switching will be initialized after user press 'Reset' button or replace the batteries.

VARIOUS FUNCTIONS

Auto Restart Control

- After recovering from power cut, the room air conditioner will automatically restored with operation mode and airflow operation set previously.
(This is because operation is not stopped by the remote controller)
- If you do not require Auto Restart Control, please contact your local sales agent.
- Auto Restart Control is not available when the Timer or Sleep Timer is set.

AUTOMATIC OPERATION

The room air conditioner automatically selects the mode, i.e. HEAT or COOL mode depending on the current room temperature. The selected operation mode will change as the room temperature changes. However, the operation mode does not change when the indoor unit is connected to a Multi Type outdoor unit.

1 Press the MODE selector button to select and display (AUTO) mode.

- When AUTO mode is selected, the room air conditioner automatically selects either HEAT or COOL mode depending on the current room temperature.
- If the mode that has been automatically selected is not satisfactory, manually change the operation mode (HEAT, DEHUMIDIFY, COOL or FAN).

2 Set the desired FAN SPEED using (FAN SPEED) button. The display indicates the setting.

3 Set the desired room temperature using (TEMP) button. The display indicates the setting. The temperature setting and the actual room temperature may vary depending on conditions. Temperature can be set between 60° ~ 90°F (16° ~ 32°C)

START STOP Press the (ON/OFF) button. Operation starts with a beep. Press the button again to stop operation.

- As the settings are stored in the memory of the remote controller, you only have to press the (ON/OFF) button next time.

HEATING OPERATION

- Use the room air conditioner for heating when the outdoor temperature lies within the range stated in Indoor Unit Operation Manual.
When the temperature is too warm, the heating operation may not work in order to protect the room air conditioner.
- To maintain the reliability of the room air conditioner, please operate when outdoor temperature is above minimum operating range.

1 Press the MODE selector button to select and display (HEAT) mode.

Set the desired FAN SPEED using (FAN SPEED) button. The display indicates the setting.

2 (AUTO) → (HIGH) → (MED) → (LOW) → (SILENT) → (AUTO)

Set the desired room temperature using (TEMP) button. The display indicates the setting.

3 The temperature setting and the actual room temperature may vary depending on conditions.
Temperature can be set between 60° ~ 90°F (16° ~ 32°C)

START STOP Press the (ON/OFF) button. Heating operation starts with a beep. Press the button again to stop operation.

- As the settings are stored in the memory of the remote controller, you only have to press the (ON/OFF) button next time.
- During Auto fan, the fan speed automatically changes as shown below:
 - When the difference between room temperature and set temperature is large, the fan starts to run at High speed.
 - The fan speed will be changed to lower speed when the room temperature reaches the preset temperature. This is to maintain optimum room temperature condition for heating.

Defrosting

Defrosting will be performed about 5 ~ 10 minutes for every 1 hour when frost forms on the heat exchanger of the outdoor unit.

During the defrost operation, the operation LED blinks in a cycle of 2 seconds on and 1 second off. The maximum time for defrosting is 20 minutes.

However, if the indoor is connected to a multi type outdoor unit, the maximum time for defrosting is 15 minutes.

(If the piping length used is longer than usual, frost is likely to form.)

COOLING OPERATION

Use the room air conditioner for cooling when the outdoor temperature lies within the range stated in Indoor Unit Operation Manual.
If indoors humidity is very high (80%), some dew may form on the air outlet grille of the indoor unit.

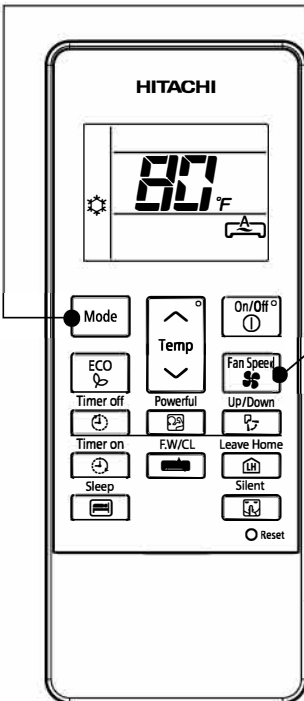

1

Press the MODE selector button to select and display  (COOL) mode.

2

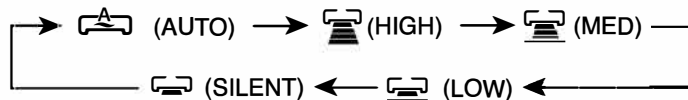

Set the desired FAN SPEED using  (FAN SPEED) button. The display indicates the setting.



3

Set the desired room temperature using  (TEMP) button. The display indicates the setting. The temperature setting and the actual room temperature may vary depending on conditions. Temperature can be set between 60° ~ 90°F (16° ~ 32°C).

**START
STOP**

Press the  (ON/OFF) button. Cooling operation starts with a beep. Press the button again to stop operation. The cooling function does not start if the temperature setting is higher than the current room temperature (even though the  (OPERATION) lamp lights). The cooling function will start as soon as user set the temperature below the current room temperature.

- As the settings are stored in the memory of the remote controller, you only have to press the  (ON/OFF) button next time.
- During Auto fan, the fan speed automatically changes as shown below:
 - When the difference between room temperature and set temperature is large, the fan starts to run at High speed.
 - The fan speed will be changed to lower speed when the room temperature reaches the preset temperature. This is to maintain optimum room temperature condition for cooling.

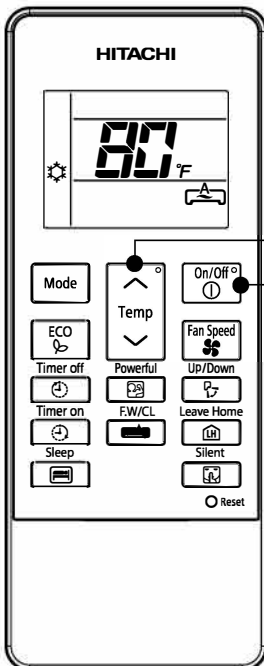

DEHUMIDIFYING OPERATION

Use the room air conditioner for dehumidifying when the room temperature is over 60°F (16°C).
When it is under 59°F (15°C), the dehumidifying function does not work.

1 Press the MODE selector button to select and display (DEHUMIDIFY) mode.
The fan speed is set at LOW.

2 Set the desired FAN SPEED with the (FAN SPEED) button.
(the display indicates the setting).

→ (LOW) → (SILENT)

3 Set the desired room temperature using (TEMP) button. The display indicates the setting.

The range between 68° ~ 78°F (20° ~ 26°C) is recommended as the room temperature for dehumidifying.
Temperature can be set between 60° ~ 90°F (16° ~ 32°C).

START STOP Press the (ON/OFF) button. Dehumidifying operation starts with a beep. Press the button again to stop operation.

- As the settings are stored in the memory of the remote controller, you only have to press the (ON/OFF) button next time.

NOTE

- When the room temperature is higher than the set temperature: The device will dehumidify the room, reducing the room temperature to the preset level.
When the room temperature is lower than the set temperature, Dehumidifying will be performed at the temperature setting slightly lower than the actual room temperature, regardless of the temperature setting.
- The preset room temperature may not be reached depending on the number of people present in the room or other room conditions.



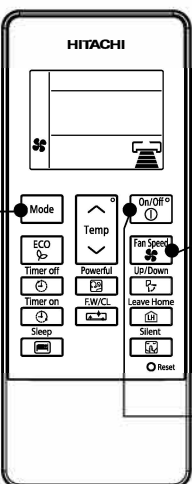

FAN OPERATION

Use the unit as an air circulator.



1 Press the MODE selector button so that the display indicates  (FAN).

2 Press the  (FAN SPEED) button.

→  (HIGH) →  (MED) →  (LOW) →  (SILENT)

START
STOP

Press the  (ON/OFF) button. Fan operation starts with a beep.
Press the button again to stop operation.

TIMER SETTING

■ ON Timer and OFF Timer are available.

Timer Off setting

- Set the timer to power off the air conditioner.
- Timer setting will change according to the sequence below when Timer Off button is pressed.

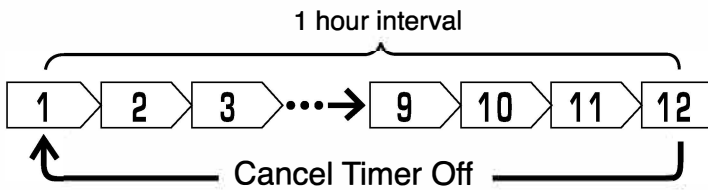

■ Operation stops at set time.

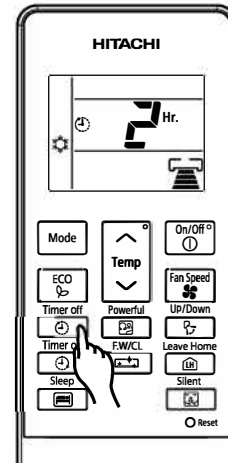

Timer On setting

- Set the timer to power on the air conditioner
- Timer setting will change according to the sequence below when Timer On button is pressed.

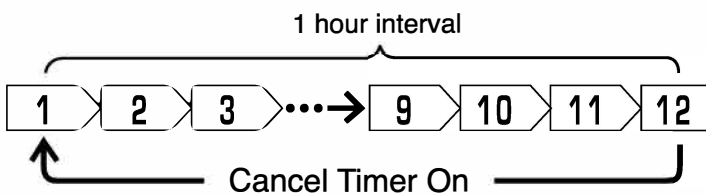

■ Operation starts at set time and temperature.

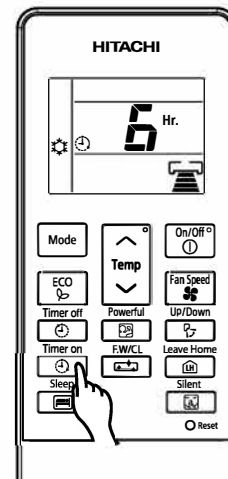

POWERFUL OPERATION

- By pressing the  (POWERFUL) button during HEATING, DEHUMIDIFYING, COOLING, FAN or AUTOMATIC operation, the air conditioner operates at maximum power.
- During POWERFUL operation, cooler or warmer air flow will be blown out from the indoor unit for COOLING or HEATING operation respectively.

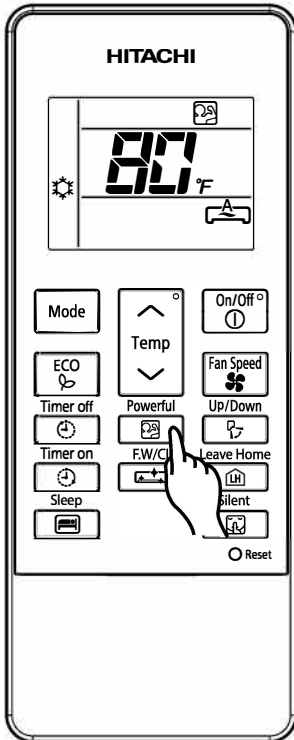



START

Press the  (POWERFUL) button during operation.

- “” is displayed on the LCD.
- POWERFUL operation ends in 20 minutes. Then, the system will automatically return to the previous settings.
- During POWERFUL operation, cooler or warmer air flow will be blown out from the indoor unit for COOLING and HEATING operation respectively.

CANCEL

- Press the  (ON/OFF) button or
 - Press the  (POWERFUL) button again.
- “” will disappear from the display.

NOTE

- When ECO mode is selected, POWERFUL operation is cancelled.
- During POWERFUL operation, capacity of the air conditioner will not increase if the air conditioner is already running at maximum capacity.
- After auto restart, POWERFUL operation is cancelled and unit will operate with previous operation.
- For Multi-model connections, POWERFUL operation may not function depending on operation conditions.

LEAVE HOME(LH) OPERATION

Use this function to prevent the room temperature from falling too much when no one is attended at home. The default setting is 50°F (10°C) and the temperature setting is between 50°~ 60°F (10°~ 16°C).

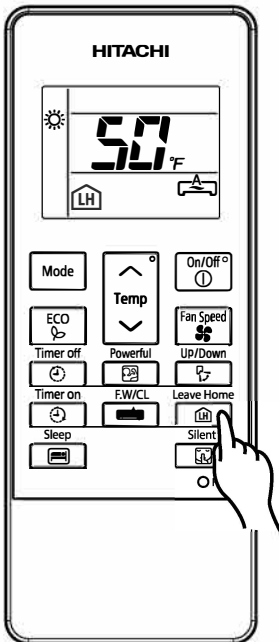

START

- 1 Press the  (LEAVE HOME) button to activate the function.





Room temperature is set at 50°F (10°C) and HEATING operation starts.

- 2 Set the desired room temperature using  (TEMP) button.

Temperature range can be set between 50°F (10°C) and 60°F (16°C).

“”, “”, “”, “SET TEMPERATURE” is displayed on the LCD.

CANCEL

- Press the  (ON/OFF) button, or
- Press the  (MODE) button, or
- Press the  (LEAVE HOME) button again.
 will disappear from the display.

NOTE

- During Leave Home operation, fan speed and horizontal air deflector position cannot be changed.

CLEAN (ONE TOUCH CLEAN) OPERATION (For Multi-model connection)

Use this function to dry the heat exchanger of the indoor unit to prevent formation of mildew.

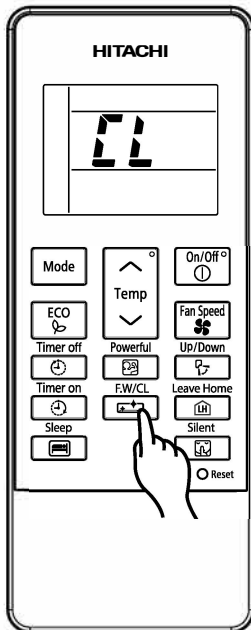

START

- Press the  (FROST WASH/CLEAN) button when unit is in Standby mode.
Total time taken for One Touch Clean operation is 60 minutes. One Touch Clean operation consists of HEATING and DRYING operation.
During One Touch Clean, operation LED lights up and “CL” is displayed on the LCD.

CANCEL

- Press the  (ON/OFF) button.

NOTE

- When CLEAN operation has finished, the unit will enter Standby mode automatically.
- If OFF TIMER or ON TIMER is pre-set, there is a need to cancel those timers before operating CLEAN function.
- For Multi-model connection, when pressing the  (FROST WASH/CLEAN), operation is limited to FAN operation only.
- For Multi-model connection, when one unit is operating CLEAN operation, the other units can operate COOLING, DEHUMIDIFYING & FAN operation.
However, when other units need to operate HEATING operation, the air conditioners will be in Standby mode. After CLEAN operation has finished, HEATING operation will start.



FROST WASH OPERATION (For single model connection)

- The dust and dirt adhering to indoor heat exchanger which is the cause of the smell. They are washed away by freezing and thawing of the heat exchanger.
- Frost Wash function can work when the outdoor temperature is 34° to 109°F (1° to 43°C) and indoor humidity is 30% to 70%.

■ Frost Wash

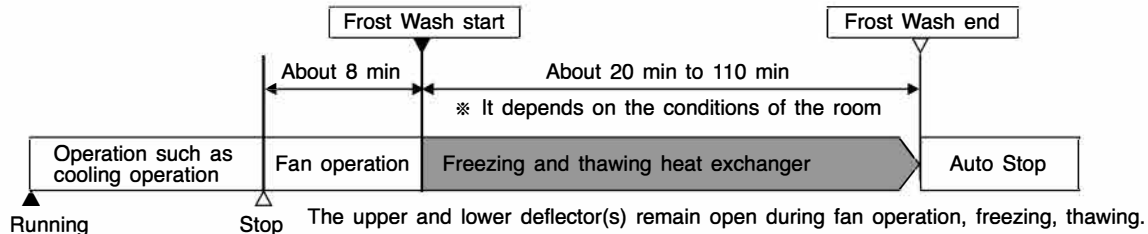
The process of Frost Wash









- “” lamp on the indoor unit lights up during Frost Wash operation.
- If you want to stop Frost Wash operation, press the  (ON/OFF) button once.
- When pressing the button such as cooling during Frost Wash operation, Frost Wash operation is discontinued and start the cooling operation after about 3 minutes.
- In order to protect the product, Frost Wash function cannot be carried out again for about 60 minutes after Frost Wash operation is completed.

■ Frost Wash (Manual mode)

When the unit is off, press  (FROST WASH/CLEAN) button, manual Frost Wash will start.

■ How to start and cancel Frost Wash (Manual mode)

- 1 Press  (FROST WASH/CLEAN) button, “” is displayed on the LCD. Frost Wash operation will start. “” lamp on the indoor unit lights up.
- After one hour, “” disappears from the LCD. After about two hours, the indoor unit will stop Frost Wash operation,
- In order to protect the product, Frost Wash function cannot be carried out again for about 60 minutes after the Frost Wash operation is completed.

- 2 Press the  (ON/OFF) button, the operation will stop. “” lamp on the indoor unit turns off.

Precautions for Use

- Do not open windows or doors during frost wash operation. Water will condense on the air deflector and drips down occasionally. This will wet your furniture.
- Do not open or remove the front panel during Frost Wash operation. It may cause injury or malfunction.
- Frost Wash operation does not wash away all dust and dirt.
- Hissing, fizzy or squeaking noise may generate during Frost Wash operation.
- If the air conditioner is continuously running, Frost Wash function is not effective.
- During Frost Wash operation, if power is turned off and then power is restored, Frost Wash function will not restart.
- After turning on the power, please wait a moment if you want to start Frost Wash.

ECO OPERATION

ECO operation is an energy saving function by changing set temperature automatically and limiting the maximum power consumption value.

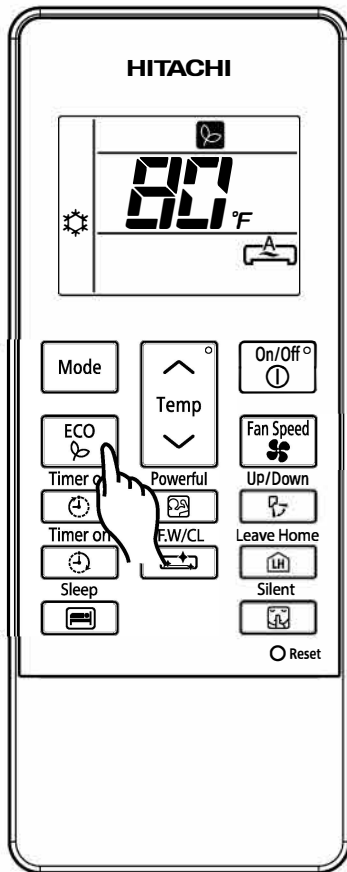

START

By pressing the  (ECO) button during HEATING, AUTO, DEHUMIDIFYING or COOLING operation, the unit performs ECO operation.

When  (ECO) button is pressed.

- “  ” is displayed on the LCD.
- Energy saving operation will start by changing the set temperature higher or lower automatically and limiting the power consumption.

CANCEL

● Press the  (ON/OFF) button, or



● Press the  (ECO) button again.

● “  ” will disappear from the LCD.

NOTE



- ECO function may not be effective when power consumption is low.
- By pressing the  (POWERFUL) button, ECO operation is cancelled.
- After auto restart, ECO operation is cancelled and unit will operate with previous operation.

SILENT OPERATION

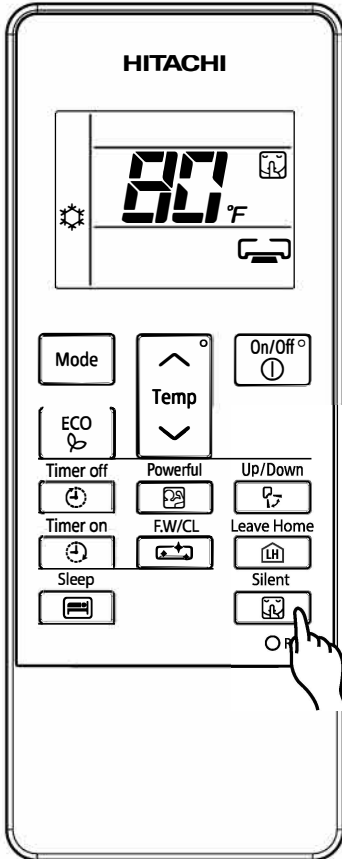

By pressing the  (SILENT) button during AUTO, HEATING, DEHUMIDIFYING, COOLING or FAN operation, fan speed will change to silent fan speed .



START

- When  button is pressed,
- “” will be displayed on the LCD.
- Fan speed will be in silent .



CANCEL

- Press the  (ON/OFF) button, or
- Press the  (SILENT) button once again or
- Press the  (FAN SPEED) button.

Fan speed will return to the previous speed before SILENT operation starts.

When SILENT operation stops, “” will disappear from the LCD.

NOTE

- When POWERFUL operation is selected, SILENT operation will be cancelled. Fan speed will return to the previous speed before SILENT operation.
- After unit auto restart, SILENT operation is cancelled. Fan speed will return to the previous speed before SILENT operation.
- During any operations with silent fan speed , if user press  (SILENT) button, the fan speed will not change.

SLEEP TIMER SETTING

By pressing the  (SLEEP) button during AUTO, HEATING, DEHUMIDIFYING, COOLING or FAN operation, the unit shifts the room temperature and reduces the fan speed.

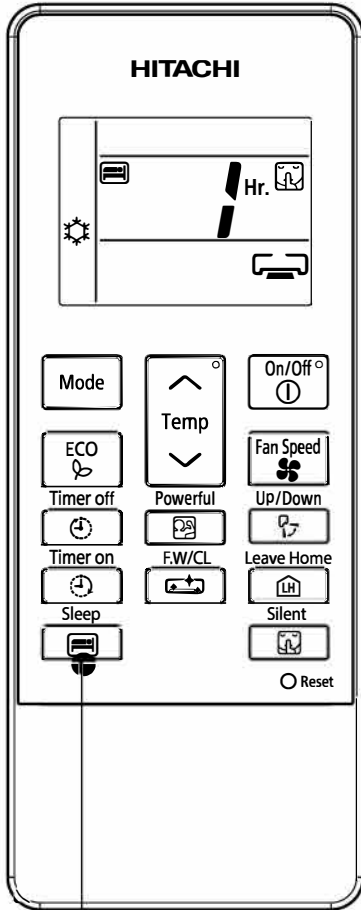

SLEEP

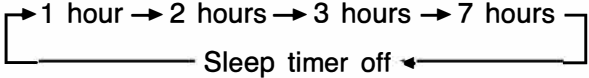
Mode	Indication
Sleep timer	

START

During Sleep Timer, the unit will continue working for the designated number of hours.



When  (SLEEP) button is pressed,

- Timer information will be displayed on the LCD.
- The timer LED lights up and a beep sound is emitted from the indoor unit.

CANCEL

- Press the  (ON/OFF) button.

Room air conditioner will enter Standby mode.

- Press the  (SLEEP) button again until timer cancels. "  " and number of hours will disappear from the LCD. The timer LED turns off and a beep sound is emitted from the indoor unit.

NOTE

- If you set SLEEP timer while ON TIMER or OFF TIMER has been pre-set, the sleep timer becomes effective instead ON TIMER or OFF TIMER.
- The indoor fan speed of air conditioner does not change even when fan speed button is pressed.

ADJUSTING THE AIRFLOW DIRECTION

1

Adjust the airflow upward and downward

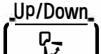
The horizontal air deflector is automatically set to the specific angle that is suitable for each operation. The deflector can swing up and down and set to desired angle by pressing  (UP/DOWN) button.

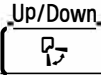
- If the “  (UP/DOWN) ” button is pressed once, the horizontal air deflector swings up and down. If the button is pressed again, the deflector stops in the current position. To have the deflector swinging once again, press the (UP/DOWN) button and it will start moving after several seconds (about 6 seconds).
- When the operation is stopped, the horizontal air deflector moves and stops at the position where the air outlet closes.

CAUTION

- In “Cooling” operation, do not keep the horizontal air deflector swinging for a long time. Some dew may be formed on the horizontal air deflector and may drop from it.

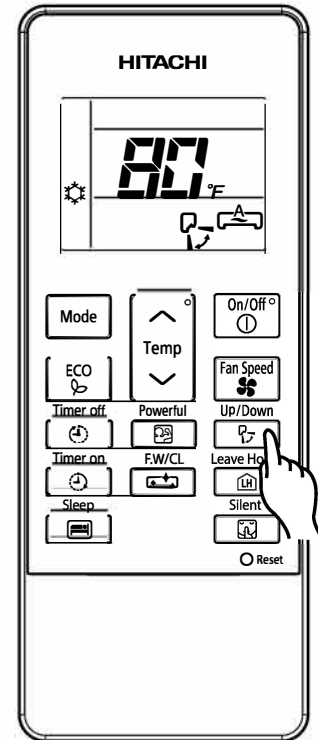

2

Adjustment of the conditioned air to the left and right.

Hold the third vertical air deflector of each set of vertical air deflectors from right as shown in the figure and adjust the conditioned air to the left or right.

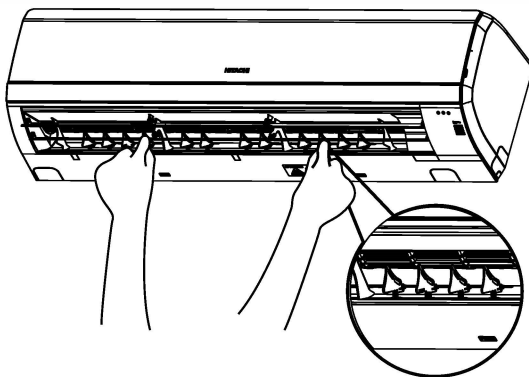

WARNING

Do not insert a finger, a rod or other objects into the air outlet or inlet as the fan is rotating at a high speed, it will cause injury. Before any cleaning or adjusting the deflectors, be sure to switch OFF the operation.

CONSTRUCTION AND DIMENSIONAL DIAGRAM

INDOOR UNIT

MODEL RAS-EH36PHLAE

Unit: Inch (mm)

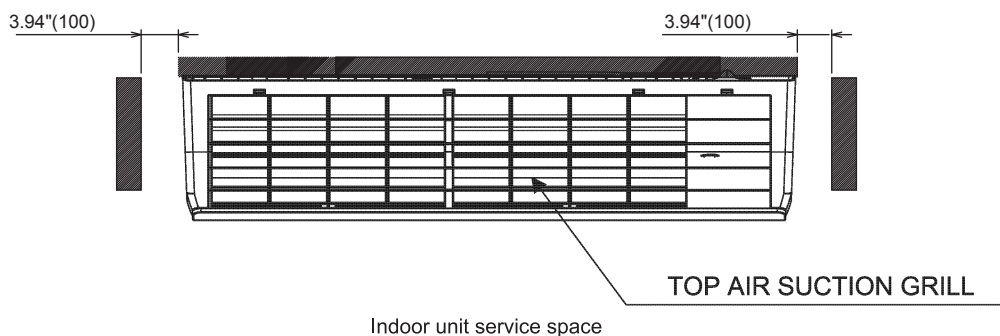
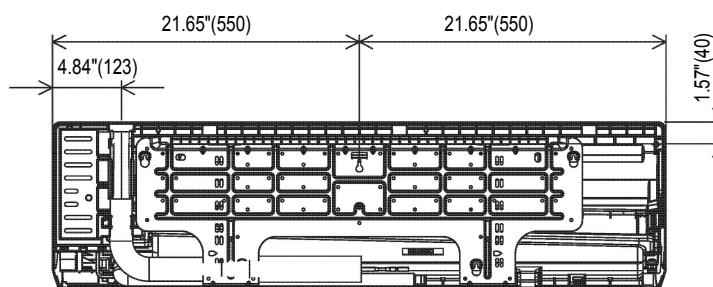
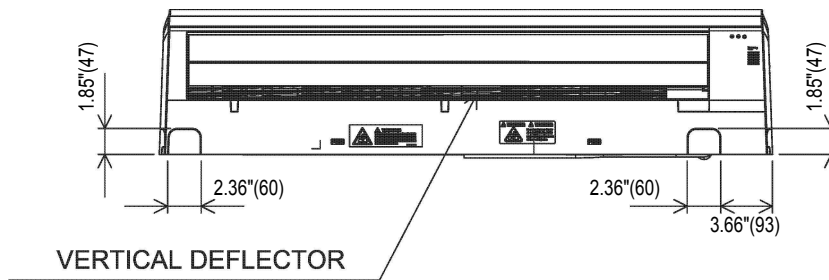
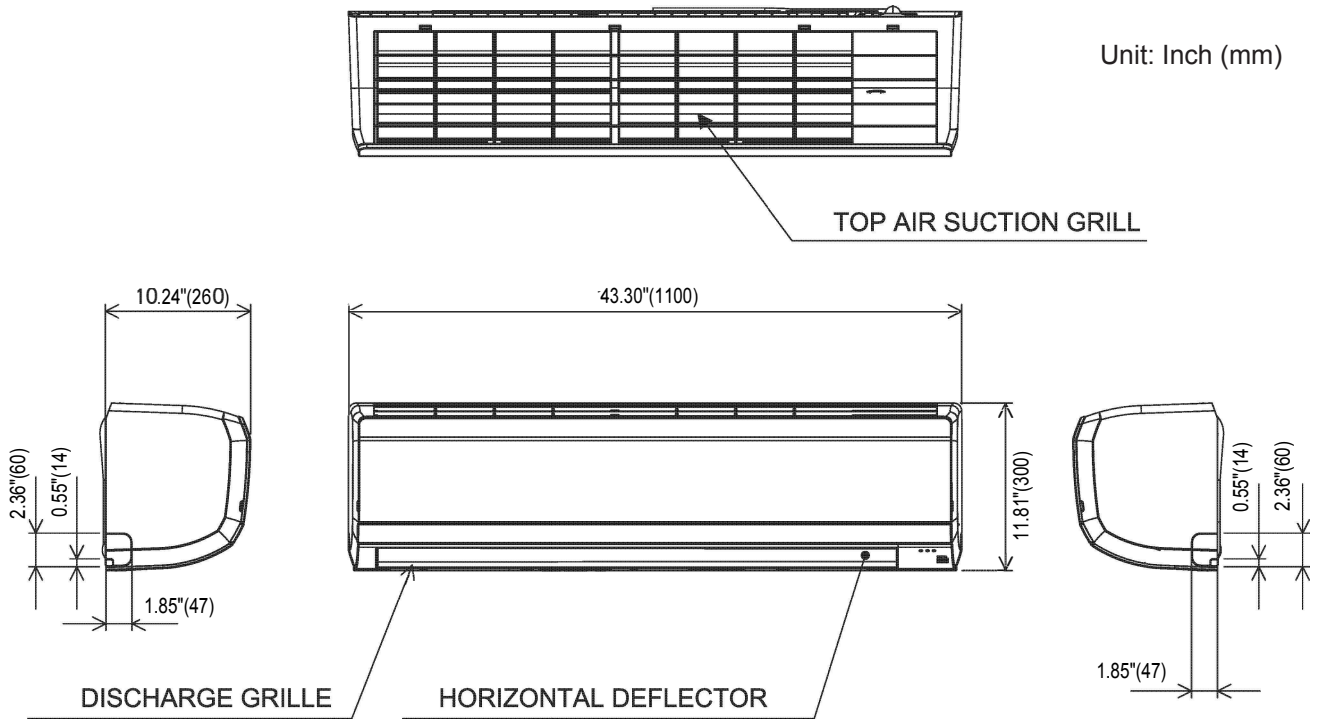

CONSTRUCTION AND DIMENSIONAL DIAGRAM FOR OUTDOOR

OUTDOOR UNIT

MODEL : RAC-EH36WHLAE

Unit: Inch (mm)

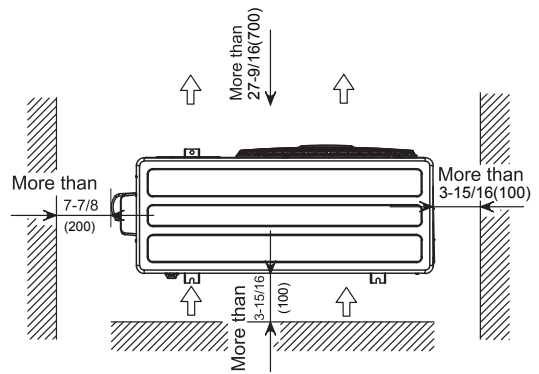
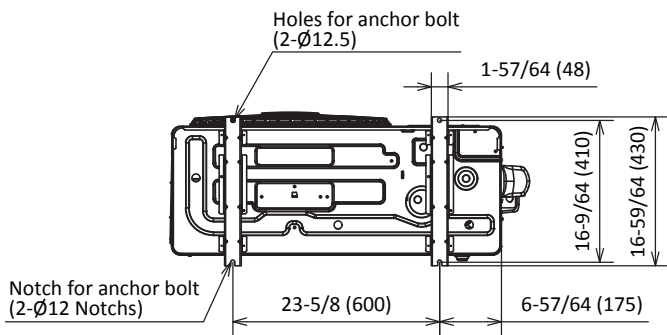
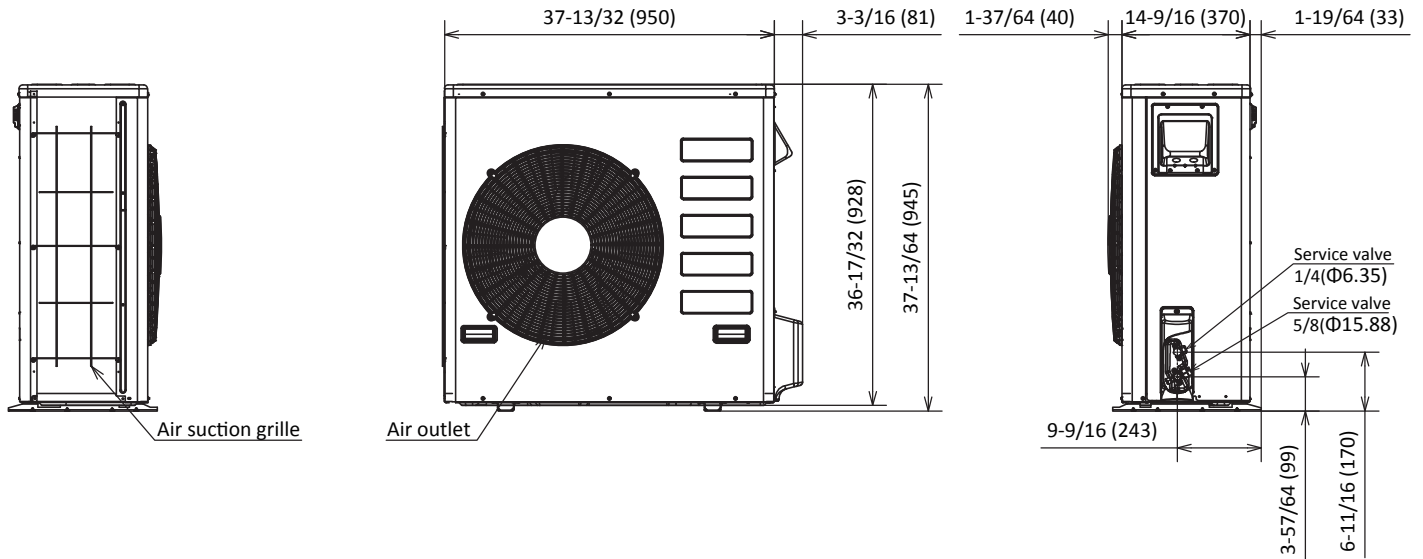

Service space

MAIN PARTS COMPONENT

THERMOSTAT (Room Temperature Thermistor)

Thermostat Specifications

MODEL			RAS-EH36PHLAE	
THERMOSTAT MODEL			IC	
OPERATION MODE			COOL	HEAT
TEMPERATURE °C(°F)	INDICATION 16	ON	15.6 (60.1)	20.0 (68.0)
		OFF	15.3 (59.5)	20.7 (69.3)
	INDICATION 24	ON	23.6 (74.5)	28.0 (82.4)
		OFF	23.3 (73.9)	28.7 (83.7)
	INDICATION 32	ON	31.6 (88.9)	36.0 (96.8)
		OFF	31.3 (88.3)	36.7 (98.1)

INDOOR FAN MOTOR

Fan Motor Specifications

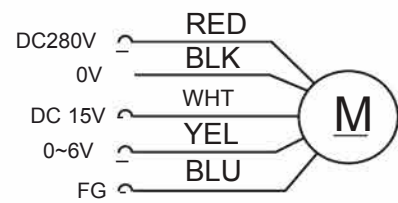
MODEL	RAS-SH36PHLAE
POWER SOURCE	DC:280V
OUTPUT	38W
CONNECTION	 <p>(Control circuit built in)</p>

OUTDOOR FAN MOTOR

Fan Motor Specifications

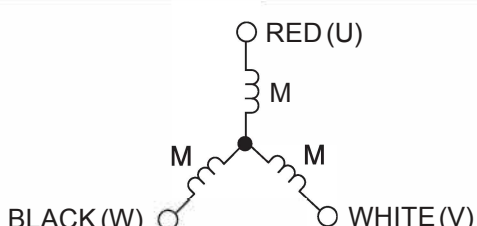
ITEM	MODEL	RAC-EH36WHLAE
POWER SOURCE		DC: 300-380V
OUTPUT	(W) MAX	120W
COIL		
RESISTANCE VALUE (Q)	20°C (60°F)	U-V:22.4 ± 2.2Ω U-W:22.4 ± 2.2Ω W-V:22.4 ± 2.2Ω

BLU : BLUE
GRY : GRAY
BLK : BLACK

YEL : YELLOW
ORN : ORANGE
PNK : PINK

BRN : BROWN
GRN : GREEN
VIO : VIOLET

WHT : WHITE
RED : RED

COMPRESSOR MOTOR

Compressor Motor Specifications

MODEL	RAC-EH36WHLAE	
COMPRESSOR MODEL	ATD253UDPC9AQ	
PHASE	SINGLE	
RATED VOLTAGE RATED	AC 220 ~ 240V	
FREQUENCY POLE	50Hz	
NUMBER	4	
CONNECTION		
RESISTANCE VALUE (Q)	20°c (68° F)	0.932

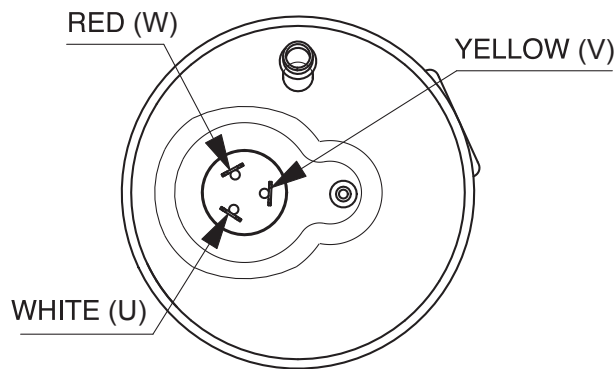

CAUTION

When the Air Conditioner has been operated for a long time with the capillary tubes clogged or crushed or with too little refrigerant, check the color of the refrigerant oil inside the compressor. If the color has been changed conspicuously, replace the compressor.

WIRING DIAGRAM

MODEL RAS-EH36PHLAE

INDOOR UNIT

BLU	BLUE	YEL	YELLOW	BRN	BROWN	WHT	WHITE
GRY	GRAY	ORN	ORANGE	GRN	GREEN	RED	RED
BLK	BLACK	PNK	PINK	VIO	VIOLET	IVO	IVORY

WIRING DIAGRAM

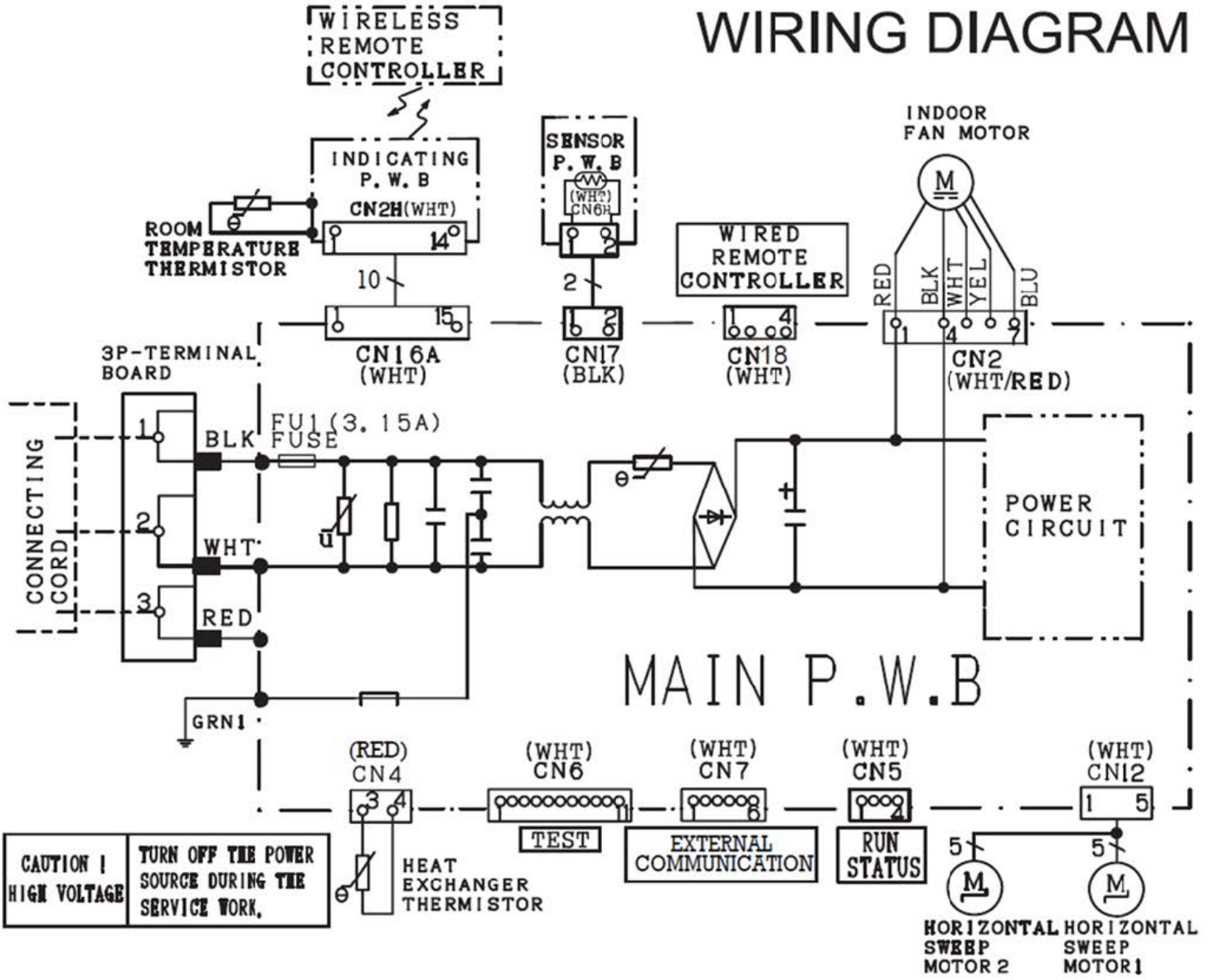

CAUTION !
HIGH VOLTAGE

TURN OFF THE POWER SOURCE DURING THE SERVICE WORK.

OUTDOOR UNIT

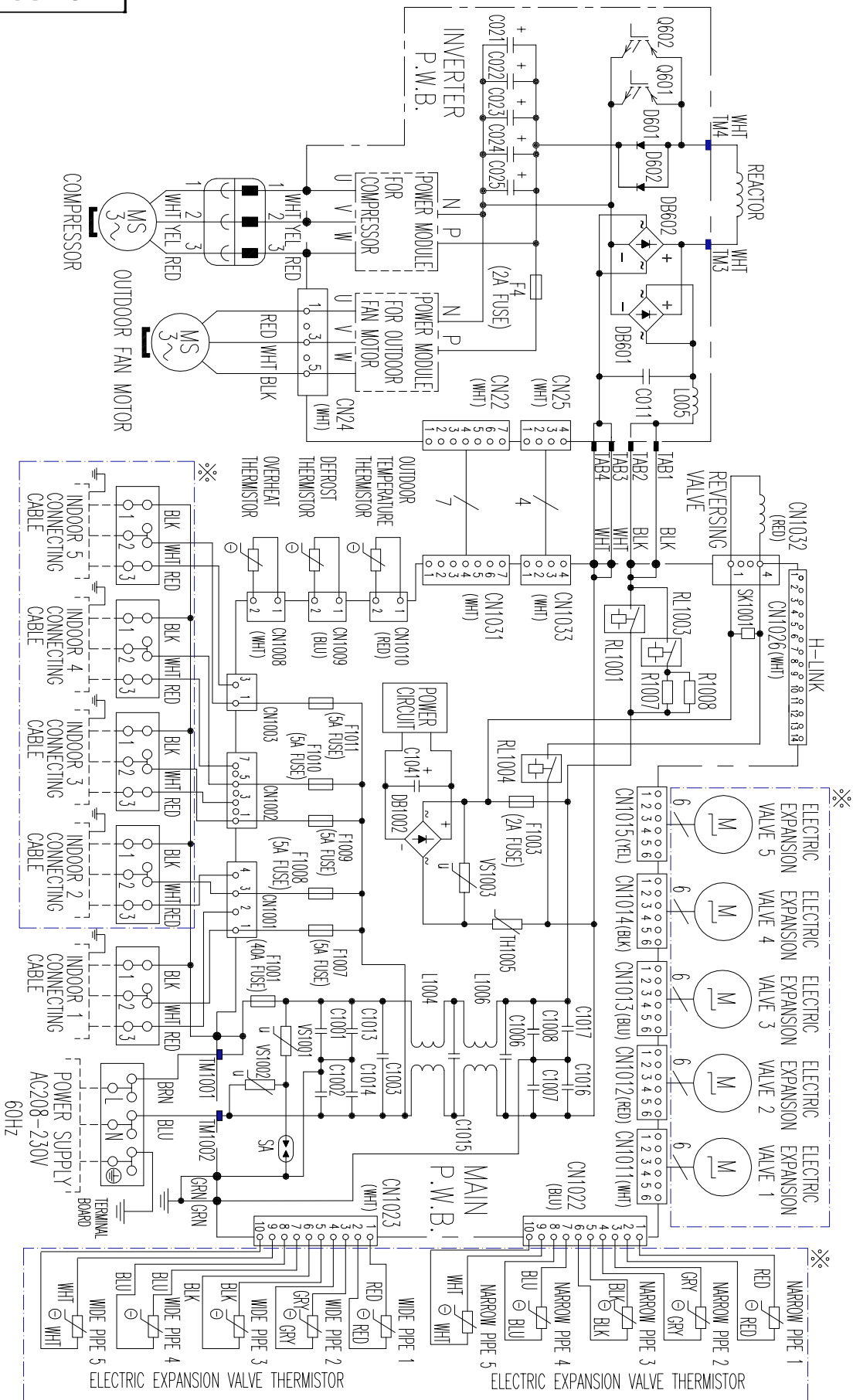

CIRCUIT DIAGRAM

Remote Controller

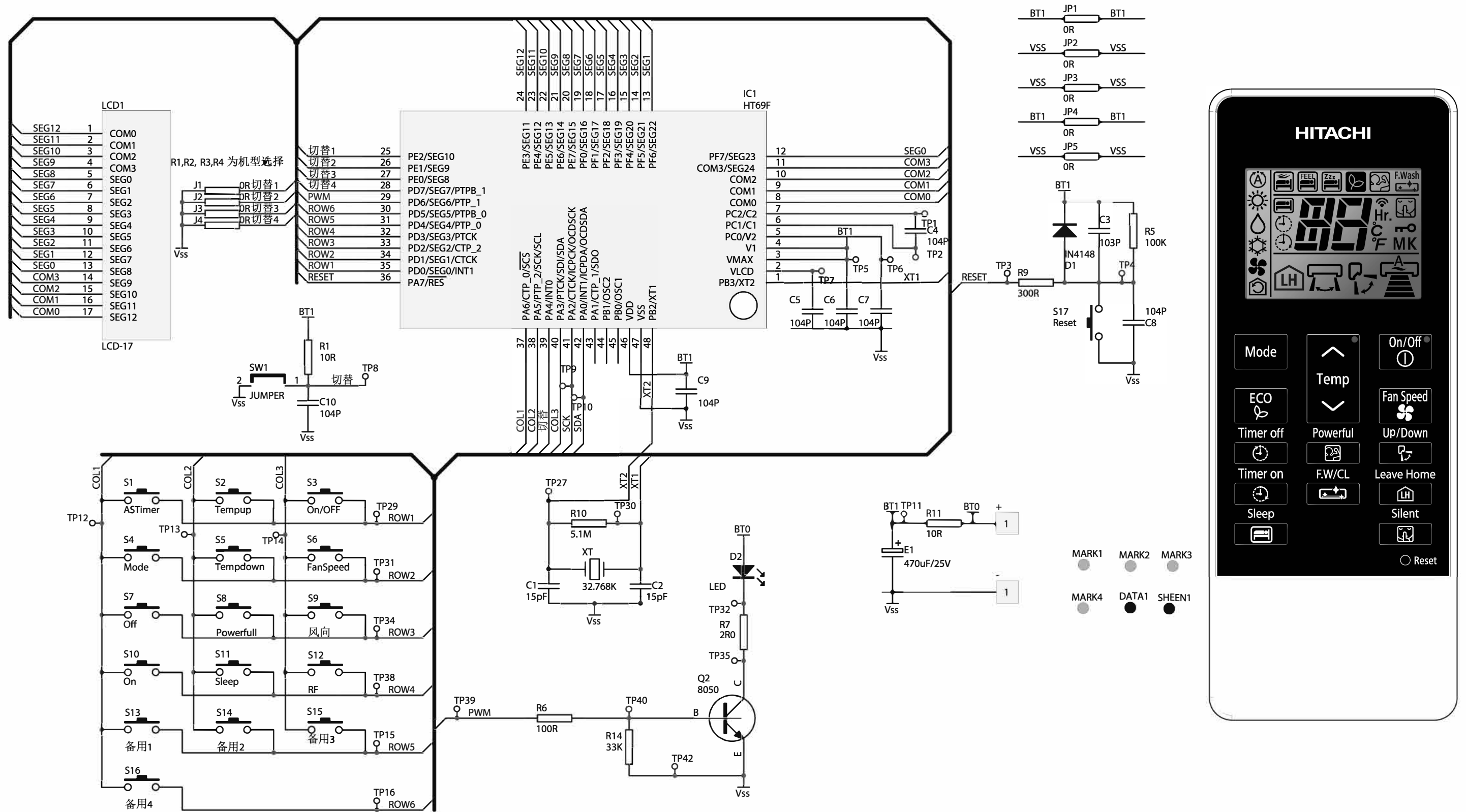

CIRCUIT DIAGRAM

MODEL RAS-EH36PLAE

- NOTES:
- TYPE OF CAPACITOR
F- FILM CAPACITOR
C- CERAMIC CAPACITOR
D- ELECTROLYTIC CAPACITOR
 - MOUNTING TYPE
A- AXIAL
R- RADIAL
P- RADIAL (7.5mm PITCH)
H- HAND INSERT
C- SURFACE MOUNT(SMT)
S- IN ADDITION SURFACE MOUNTING
 - MOUNTING FACE
A- COMPONENT SIDE
B- SOLDER SIDE
 - PCB DETAILS--

BOARD	TYPE	DRAWING	FORM
MAIN PWB	#INSERT-AS	DD0010111A	A.R.C.S
INDICATION PWB	#HBOARD-AS	DD0010318A	H
SENSOR PWB	#MS-BOARD	DD0006635C	A.R.C.S.H
		DD0006635B	A.R.C.S.H

RESISTOR

SYMBOL	VALUE	TOLERANCE	WATT	FORM	GROUP	REMARK	ASSY NO.
R001	10K	5%	1/16	C	A, B	1005 68	
R002	1M	5%	1/4	A, B	A, B	HVL 17	
R101	1k	5%	1/4	C	A, B	3226 18	
R102	1.5k	5%	1/10	C	A, B	1608 56	
R103	10k	5%	1/10	C	A, B	1005 61	
R105	3k	5%	1/10	C	A, B	1608 57	
R122	33k	5%	1/2	A, B	HVL		
R126	10k	5%	1/10	C	A, B	1608 39	
R127	330k	5%	1/10	C	A, B	1608 40	
R128	100k	1%	1/10	C	A, B	1608 41	
R129	6.2k	1%	1/10	C	A, B	1608 46	
R132	1.2	5%	1	R	A, B	MOS 7	
R133	330k	5%	1/10	C	A, B	1608 63	
R134	22	5%	1/2	A, B	A, B	RSS 11	
R141	100k	5%	1/16	C	A, B	1005 53	
R142	150k	5%	1/16	C	A, B	1005 53	
R143	3.3k	5%	1/16	C	A, B	1005 77	
R144	3.3k	5%	1/16	C	A, B	1005 77	
R145	0	5%	1/10	C	A, B	1608 48	
R146	40.2k	1%	1/10	C	A, B	1608 35	
R147	9.1k	1%	1/10	C	A, B	1608 36	
R148	11k	1%	1/10	C	A, B	1608 37	
R161	220k	5%	1	R	A, B	RTT105 12	
R162	68	5%	1	R	A, B	12	
R201	4.3k	5%	1/4	C	A, B	3216 28	
R202	4.3k	5%	1/4	C	A, B	1608 59	
R203	4.7k	5%	1/8	C	A, B	2125 43	
R204	3.3k	5%	1/10	C	A, B	1608 58	
R205	402	1%	1/4	C	A, B	3216 31	
R206	33k	5%	1/10	C	A, B	1608 62	
R207	100	5%	1/10	C	A, B	1608 52	
R211	10k	5%	1/10	C	A, B	1608 61	
R212	1k	5%	1/10	C	A, B	1608 60	
R213	390	5%	1/8	C	A, B	2125 49	
R214	560	5%	1/4	C	A, B	3226 19	
R215	10k	5%	1/10	C	A, B	1608 61	
R216	1k	5%	1/10	C	A, B	1608 60	
R217	1k	5%	1/10	C	A, B	1608 60	
R218	1k	5%	1/10	C	A, B	1608 60	
R219	1k	5%	1/10	C	A, B	1608 60	
R220	1k	5%	1/10	C	A, B	1608 60	
R221	1k	5%	1/10	C	A, B	1608 60	
R222	1k	5%	1/10	C	A, B	1608 60	
R223	1k	5%	1/10	C	A, B	1608 60	
R224	1k	5%	1/10	C	A, B	1608 60	
R225	1k	5%	1/10	C	A, B	1608 60	
R226	1k	5%	1/10	C	A, B	1608 60	
R227	1k	5%	1/10	C	A, B	1608 60	
R228	1k	5%	1/10	C	A, B	1608 60	
R229	1k	5%	1/10	C	A, B	1608 60	
R230	1k	5%	1/10	C	A, B	1608 60	
R231	1k	5%	1/10	C	A, B	1608 60	
R232	1k	5%	1/10	C	A, B	1608 60	
R233	1k	5%	1/10	C	A, B	1608 60	
R234	1k	5%	1/10	C	A, B	1608 60	
R235	1k	5%	1/10	C	A, B	1608 60	
R236	1k	5%	1/10	C	A, B	1608 60	
R237	1k	5%	1/10	C	A, B	1608 60	
R238	1k	5%	1/10	C	A, B	1608 60	
R239	1k	5%	1/10	C	A, B	1608 60	
R240	1k	5%	1/10	C	A, B	1608 60	
R241	1k	5%	1/10	C	A, B	1608 60	
R242	1k	5%	1/10	C	A, B	1608 60	
R243	1k	5%	1/10	C	A, B	1608 60	
R244	1k	5%	1/10	C	A, B	1608 60	
R245	1k	5%	1/10	C	A, B	1608 60	
R246	1k	5%	1/10	C	A, B	1608 60	
R247	1k	5%	1/10	C	A, B	1608 60	
R248	1k	5%	1/10	C	A, B	1608 60	
R249	1k	5%	1/10	C	A, B	1608 60	
R250	1k	5%	1/10	C	A, B	1608 60	
R251	1k	5%	1/10	C	A, B	1608 60	
R252	1k	5%	1/10	C	A, B	1608 60	
R253	1k	5%	1/10	C	A, B	1608 60	
R254	1k	5%	1/10	C	A, B	1608 60	
R255	1k	5%	1/10	C	A, B	1608 60	
R256	1k	5%	1/10	C	A, B	1608 60	
R257	1k	5%	1/10	C	A, B	1608 60	
R258	1k	5%	1/10	C	A, B	1608 60	
R259	1k	5%	1/10	C	A, B	1608 60	
R260	1k	5%	1/10	C	A, B	1608 60	
R261	1k	5%	1/10	C	A, B	1608 60	
R262	1k	5%	1/10	C	A, B	1608 60	
R263	1k	5%	1/10	C	A, B	1608 60	
R264	1k	5%	1/10	C	A, B	1608 60	
R265	1k	5%	1/10	C	A, B	1608 60	
R266	1k	5%	1/10	C	A, B	1608 60	
R267	1k	5%	1/10	C	A, B	1608 60	
R268	1k	5%	1/10	C	A, B	1608 60	
R269	1k	5%	1/10	C	A, B	1608 60	
R270	1k	5%	1/10	C	A, B	1608 60	
R271	1k	5%	1/10	C	A, B	1608 60	
R272	1k	5%	1/10	C	A, B	1608 60	
R273	1k	5%	1/10	C	A, B	1608 60	
R274	1k	5%	1/10	C	A, B	1608 60	
R275	1k	5%	1/10	C	A, B	1608 60	
R276	1k	5%	1/10	C	A, B	1608 60	
R277	1k	5%	1/10	C	A, B	1608 60	
R278	1k	5%	1/10	C	A, B	1608 60	
R279	1k	5%	1/10	C	A, B	1608 60	
R280	1k	5%	1/10	C	A, B	1608 60	
R281	1k	5%	1/10	C	A, B	1608 60	
R282	1k	5%	1/10	C	A, B	1608 60	
R283	1k	5%	1/10	C	A, B	1608 60	
R284	1k	5%	1/10	C	A, B	1608 60	
R285	1k	5%	1/10	C	A, B	1608 60	
R286	1k	5%	1/10	C	A, B	1608 60	
R287	1k	5%	1/10	C	A, B	1608 60	
R288	1k	5%	1/10	C	A, B	1608 60	
R289	1k	5%	1/10	C	A, B	1608 60	
R290	1k	5%	1/10	C	A, B	1608 60	
R291	1k	5%	1/10	C	A, B	1608 60	
R292	1k	5%	1/10	C	A, B	1608 60	
R293	1k	5%	1/10	C	A, B	1608 60	
R294	1k	5%	1/10	C	A, B	1608 60	
R295	1k	5%	1/10	C	A, B	1608 60	
R296	1k	5%	1/10	C	A, B	1608 60	
R297	1k	5%	1/10	C	A, B	1608 60	
R298	1k	5%	1/10	C	A, B	1608 60	
R299	1k	5%	1/10	C	A, B	1608 60	
R300	1k	5%	1/10	C	A, B	1608 60	
R301	1k	5%	1/10	C	A, B	1608 60	
R302	1k	5%	1/10	C	A, B	1608 60	
R303	1k	5%	1/10	C	A, B	1608 60	
R304	1k	5%	1/10	C	A, B	1608 60	
R305	1k	5%	1/10	C	A, B	1608 60	
R306	1k	5%	1/10	C	A, B	1608 60	
R307	1k	5%	1/10	C	A, B	1608 60	
R308	1k	5%	1/10	C	A, B	1608 60	
R309	1k	5%	1/10	C	A, B	1608 60	
R310	1k	5%	1/10	C	A, B	1608 60	
R311	1k	5%	1/10	C	A, B	1608 60	
R312	1k	5%	1/10	C	A, B	1608 60	
R313	1k	5%	1/10	C	A, B	1608 60	
R314	1k	5%	1/10	C	A, B	1608 60	
R315	1k	5%	1/10	C	A, B	1608 60	
R316	1k	5%	1/10	C	A, B	1608 60	
R317	1k	5%	1/10	C	A, B	1608 60	
R318	1k	5%	1/10	C	A, B	1608 60	
R319	1k	5%	1/10	C	A, B	1608 60	
R320	1k	5%	1/10	C	A, B	1608 60	
R321	1k	5%	1/10	C	A, B	1608 60	
R322	1k	5%	1/10	C	A, B	1608 60	
R323	1k	5%	1/10	C	A, B	1608 60	
R324	1k	5%	1/10	C	A, B	1608 60	
R325	1k	5%	1/10	C	A, B	1608 60	
R326	1k	5%	1/10	C	A, B	1608 60	
R327	1k	5%	1/10	C	A, B	1608 60	
R328	1k	5%	1/10	C	A, B	1608 60	
R329	1k	5%	1/10	C	A, B	1608 60	
R330	1k	5%	1/10	C	A, B	1608 60	
R331	1k	5%	1/10	C	A, B	1608 60	
R332	1k	5%	1/10	C	A, B	1608 60	
R333	1k	5%	1/10	C	A, B	1608 60	
R334	1k	5%	1/10	C	A, B	1608 60	
R335	1k	5%	1/10	C	A, B	1608 60	
R336	1k	5%	1/10	C	A, B	1608 60	
R337	1k	5%	1/10	C	A, B	1608 60	
R338	1k	5%	1/10	C	A, B	1608 60	
R339	1k	5%	1/10	C	A, B	1608 60	
R340	1k	5%	1/10	C	A, B	1608 60	
R341	1k	5%	1/10	C	A, B	1608 60	
R342	1k	5%	1/10	C	A, B	1608 60	
R343	1k	5%	1/10	C	A, B	1608 60	
R344	1k	5%	1/10	C	A, B	1608 60	
R345	1k	5%	1/10	C	A, B	1608 60	
R346	1k	5%	1/10	C	A, B	1608 60	
R347	1k	5%	1/10	C	A, B	1608 60	
R348	1k	5%	1/10	C	A, B	1608 60	
R349	1k	5%	1/10	C	A, B	1608 60	
R350	1k	5%	1/10	C	A, B	1608 60	

RESISTOR

SYMBOL	VALUE	TOLERANCE	WATT	FORM	GROUP	REMARK	ASSY NO.
R501	10k	5%	1/16	C	A, B	1005 68	
R502	1M	5%	1/4	A, B	A, B	HVL 17	
R503	1k	5%	1/4	C	A, B	3226 18	
R504	1.5k	5%	1/10	C	A, B	1608 56	
R505	10k	5%	1/10	C	A, B	1005 61	
R506	3k	5%	1/10	C	A, B	1608 57	
R507	33k	5%	1/2	A, B	HVL		
R508	10k	5%	1/10	C	A, B	1608 39	
R509	330k	5%	1/10	C	A, B	1608 40	
R510	100k	1%	1/10	C	A, B	1608 41	
R511	6.2k	1%	1/10	C	A, B	1608 46	
R512	1.2	5%	1	R	A, B	MOS 7	
R							

PRINTED BOARD LOCATION DIAGRAM

MODEL: RAS-EH36PHLAE

MAIN P.W.B

Marking on P.W.B

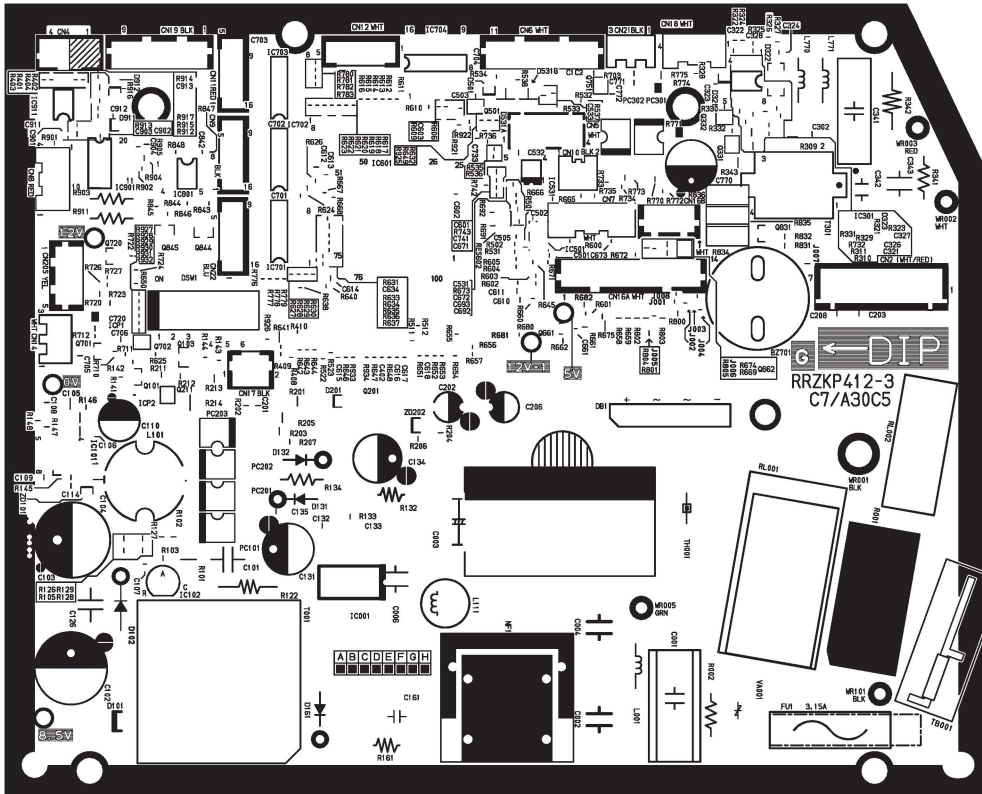

RECEIVING P.W.B
Marking on P.W.B

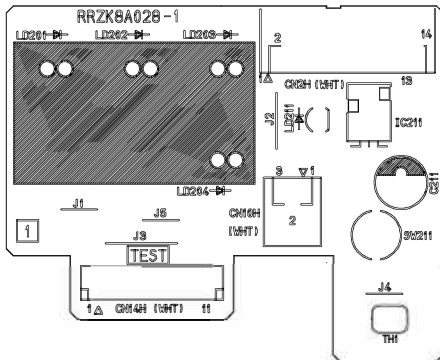

SENSOR P.W.B
Marking on P.W.B

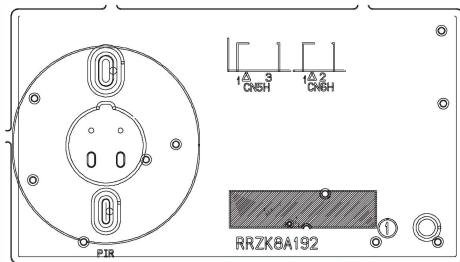

Main board [solder side]

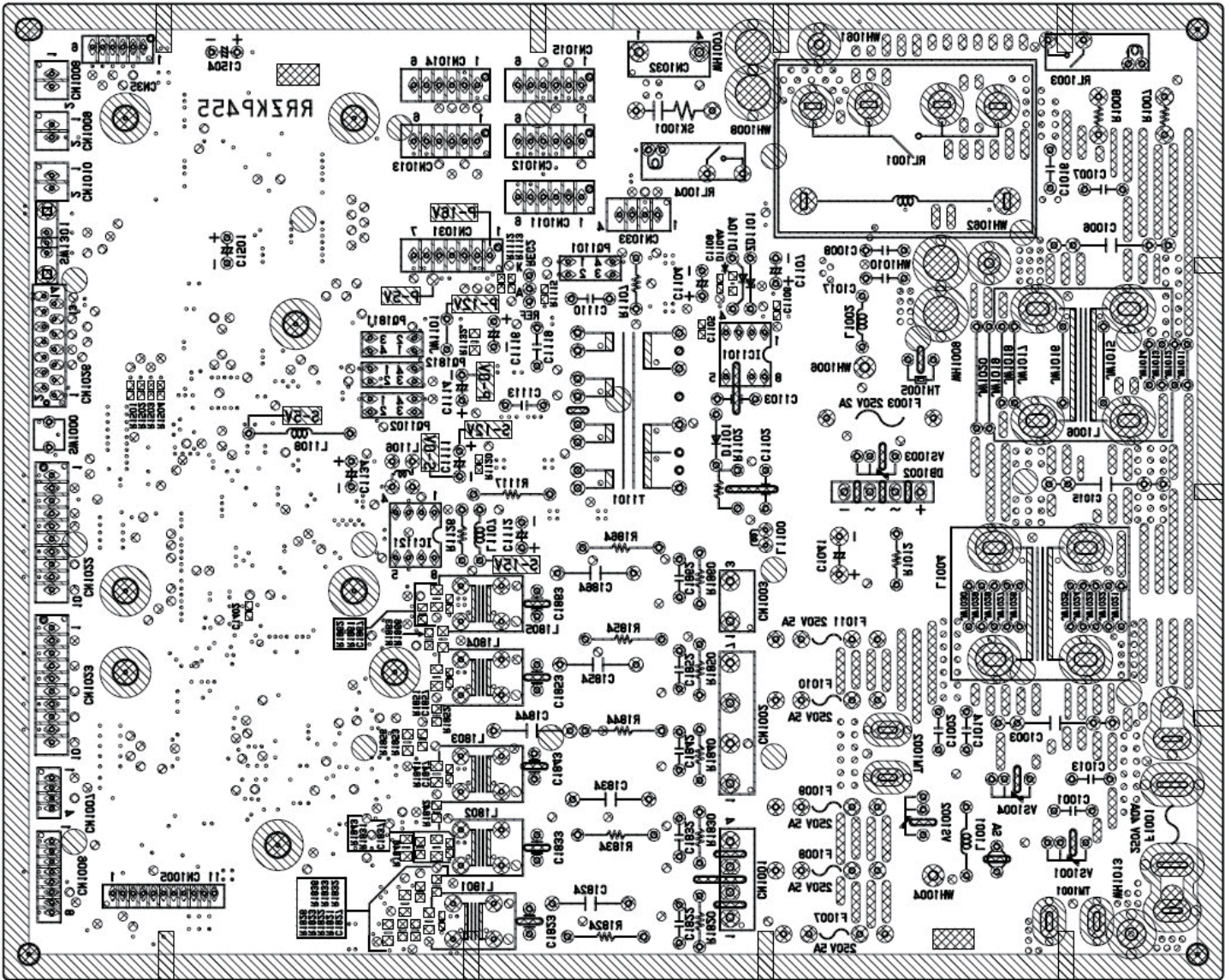

Inverter board [component side]

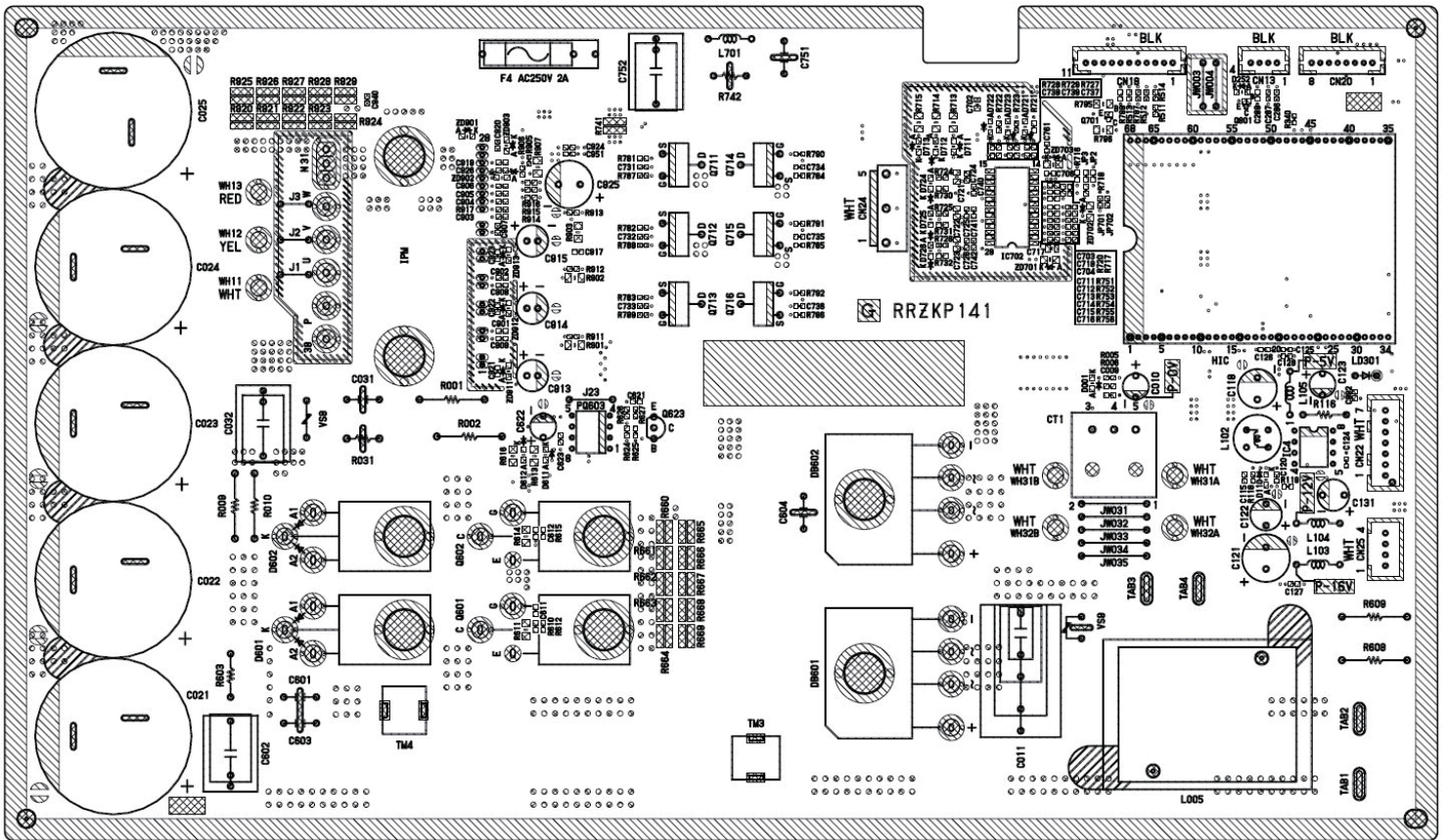

Inverter board [solder side]

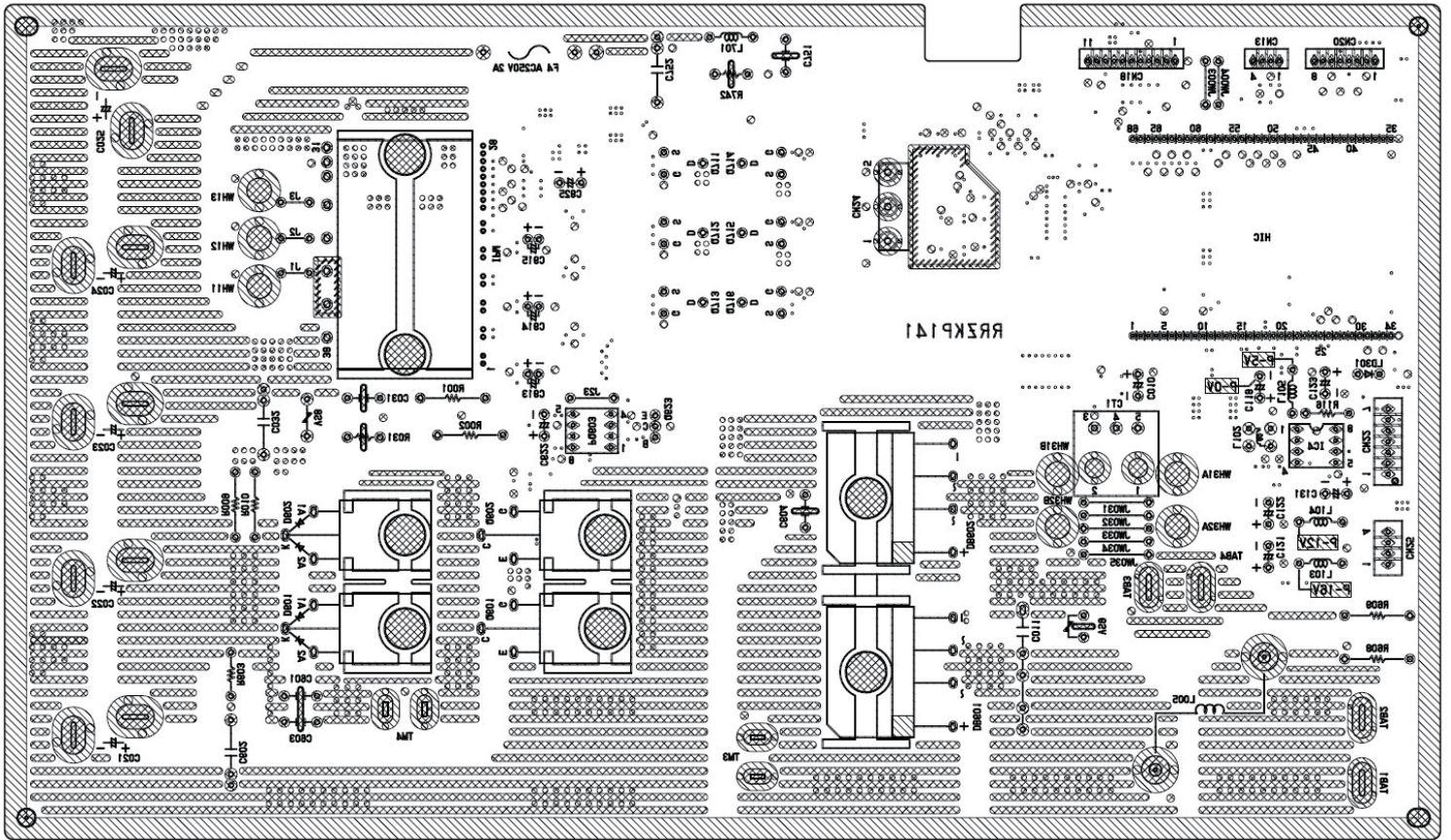

[Inverter HIC board] top side

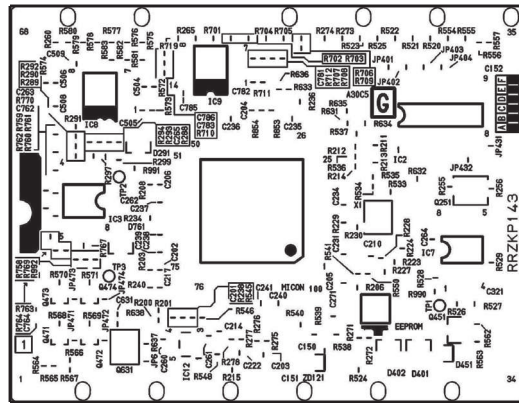

[Inverter HIC board] bottom side

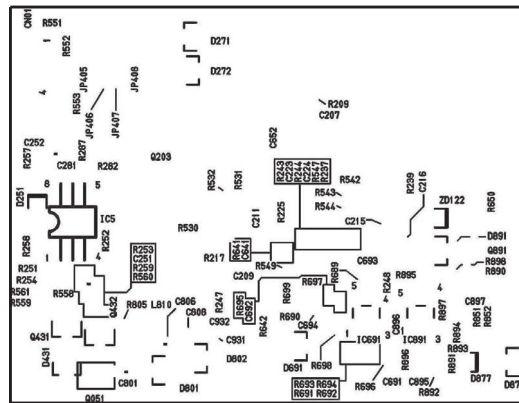

BLOCK DIAGRAM

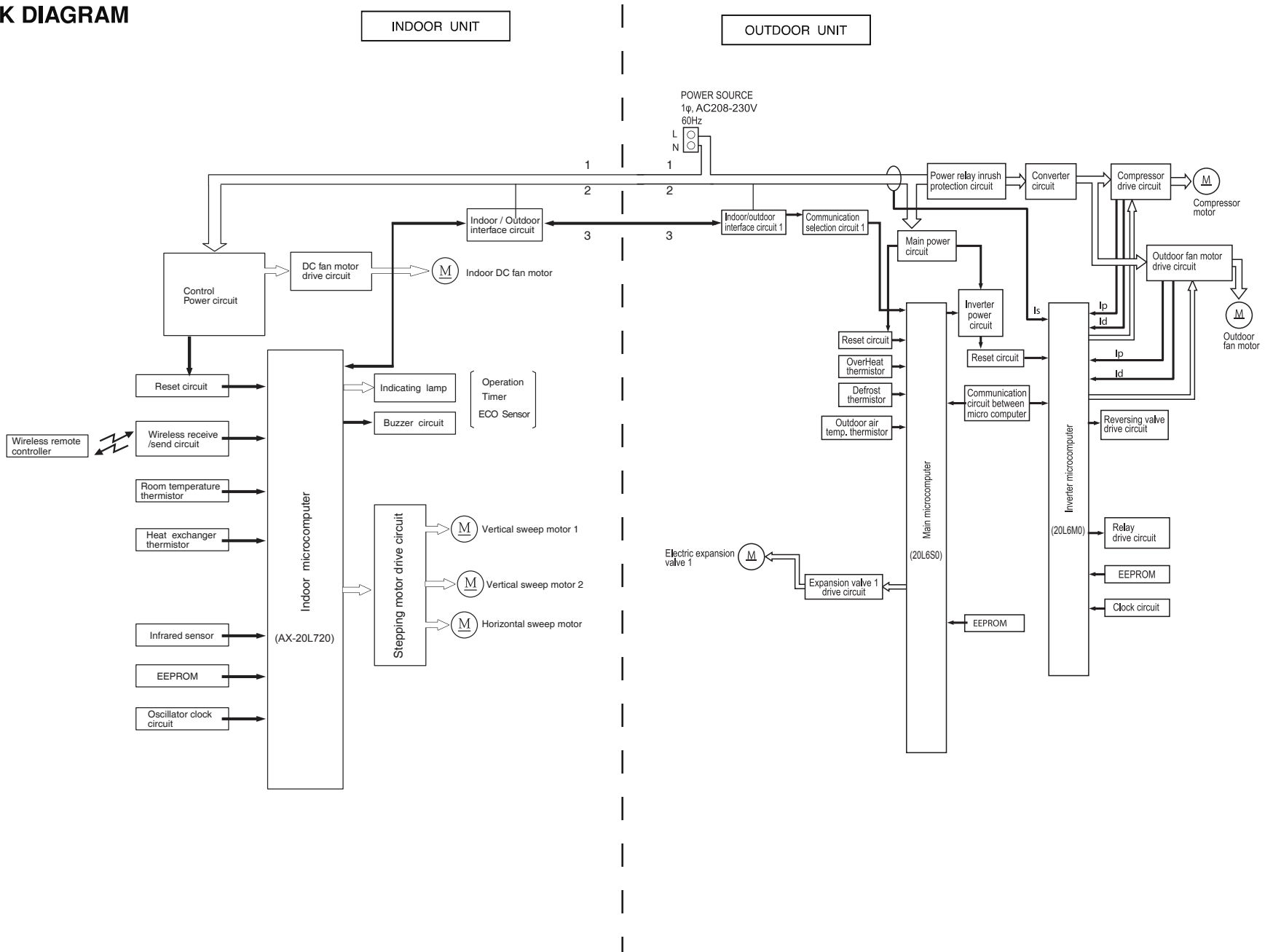

BASIC MODE

Operation mode	Fan	Cooling	Dehumidifying	Heating	Auto	
Basic operation of start/stop button						
Timer functions	Off-timer					
	On-timer					
Fan speed mode (indoor fan)	Auto	<p>Changes from "Hi" to "Med" or "Lo" depending on room temperature.</p> <ol style="list-style-type: none"> Runs at "Hi" until room temperature reaches to "setting temperature-SFTDSC" after operation is started. Runs at "ultra-Lo" when thermo is off. 		<p>Set to "ultra-Lo", "Silent", "Lo", "Med", "Hi", "ultra-Hi" or "stop" depending on the room temperature, time and heat exchanger temperature. Set to "stop" if the heat exchanger temperature is "DNZKOF" during Thermo OFF. (When reach at "DNZKON", fan speed set to "ultra-Lo" again.)</p>	<p>Operating mode is judged by room temperature.</p> <p>(1) Judging by room temperature (Initial judgement)</p> <p>(a) Conditions for judgment (any of the followings).</p> <ul style="list-style-type: none"> When auto operation is started after the previous auto mode operation. When auto operation is started after the previous manual mode operation. When the operating mode is switched to auto while operating at manual mode. <p>(b) Judging method</p> <ul style="list-style-type: none"> [Cooling] : Room temperature \geq Remote controller setting [Heating] : Room temperature $<$ Remote controller setting 	
	Hi	Operates at "Hi" regardless of the room temperature.	Set to "ultra-Hi" when the compressor runs at cold dash mode speed, and to "Hi" in other modes. Runs at "ultra-Lo" when thermo is off.		Set to "ultra-Lo", "Silent", "Lo", "Med", "Hi", "ultra-Hi" or "stop" depending on the room temperature, time and heat exchanger temperature. Set to "stop" if the heat exchanger temperature is "DNZKOF" during Thermo OFF. (When reach at "DNZKON", fan speed set to "ultra-Lo" again.)	<p>(2) Judging by room temperature (continuous judgement)</p> <p>(a) Judging condition</p> <ul style="list-style-type: none"> Operating mode will be judge again after auto mode interval time (1) 1st interval [autmn1_8u] (2) 2nd interval [autmn2_8u] (3) 3rd and next interval [autmn3_8u] <p>(b) Judging method</p> <ul style="list-style-type: none"> Judging method will follow as below Final set temperature is remote controller setting including shift value <p>[Current operation is COOLING]</p> <ul style="list-style-type: none"> Room temperature \leq Final set temperature - [nwautw_8u], change to HEATING Room temperature $>$ Final set temperature - [nwautw_8u], continue in COOLING <p>[Current operation is HEATING]</p> <ul style="list-style-type: none"> Room temperature \geq Final set temperature + [nwautc_8u], change to COOLING Room temperature $>$ Final set temperature + [nwautc_8u], continue in HEATING
	Med	Operates at "Med" regardless of the room temperature.	Operates at "Med" regardless of the room temperature. Runs at "ultra-Lo" when thermo is off.		Set to "ultra-Lo", "Silent", "Lo", "Med", "Hi", "ultra-Hi" or "stop" depending on the room temperature, time and heat exchanger temperature. Set to "stop" if the heat exchanger temperature is "DNZKOF" during Thermo OFF. (When reach at "DNZKON", fan speed set to "ultra-Lo" again.)	
	Lo	Operates at "Lo" regardless of the room temperature.	Operates at "Lo" regardless of the room temperature. Runs at "ultra-Lo" when thermo is off.	Set to "Lo" in modes other than when the compressor stops.	Set to "ultra-Lo", "Silent", "Lo", "Med", "Hi", "ultra-Hi" or "stop" depending on the room temperature, time and heat exchanger temperature. Set to "stop" if the heat exchanger temperature is "DNZKOF" during Thermo OFF. (When reach at "DNZKON", fan speed set to "ultra-Lo" again.) The fan speed is controlled by the heat exchanger temperature; the overload control is executed as in the following diagram:	
	Silent	Operates at "Silent" regardless of the room temperature.	Operates at "Silent" regardless of the room temperature. Runs at "ultra-Lo" when thermo is off.	Set to "Silent" in modes other than when the compressor stops.		
Basic operation of temperature controller	Performs only fan operation at the set speed regardless of the room temperature.	See page 55	See page 57	See page 59	Follow basic cooling or heating operation	

Basic Cooling Operation

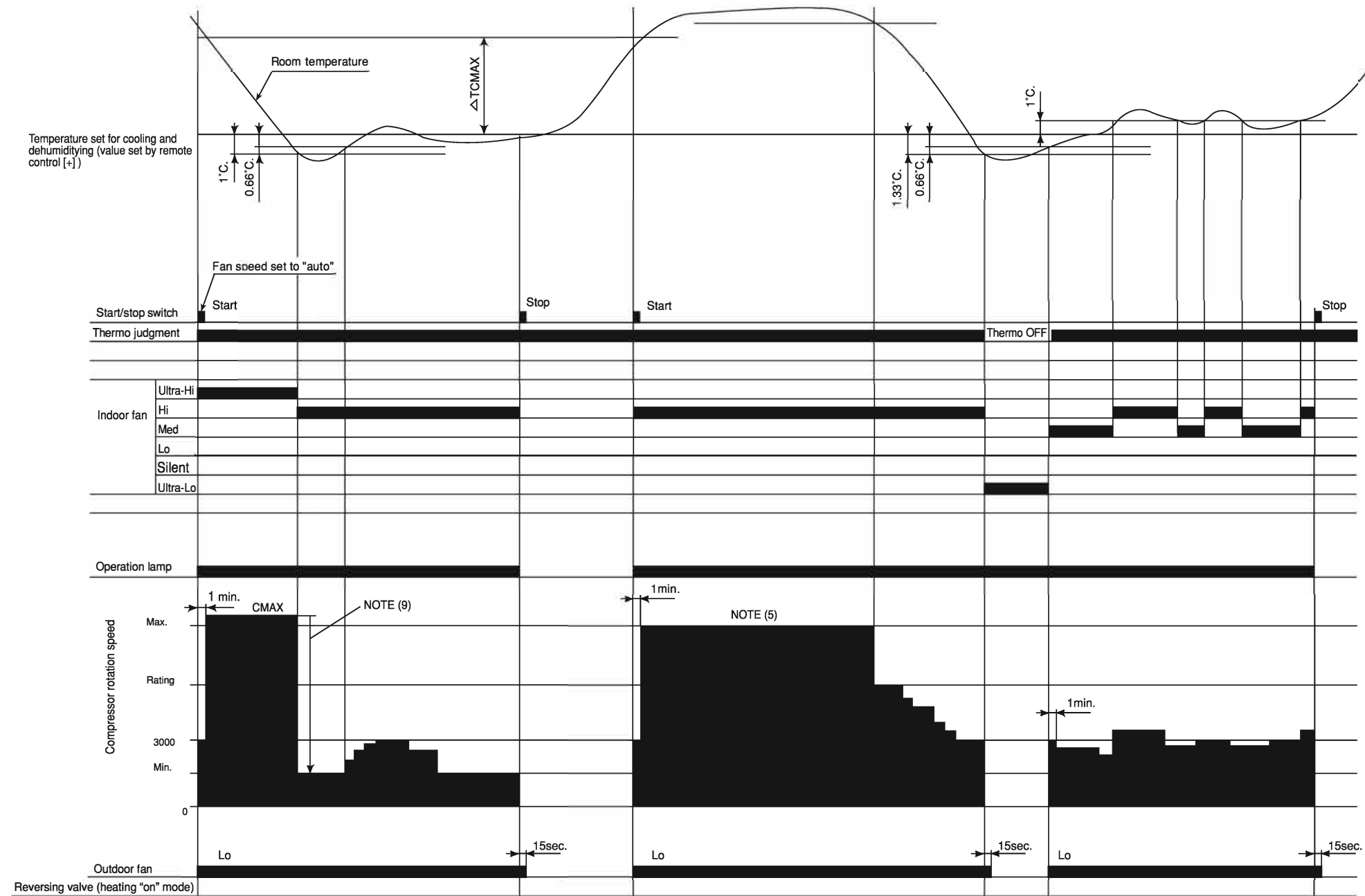

Notes:

- (1) Condition for entering into Cool Dashed mode. When fan set to "Hi" or "Auto and when the compressor speed (P section) due to temperature difference between setting temperature (including the correction shift only) and room temperature is CMAX or higher.
- (2) Cool Dashed will release when i) a maximum 25 minutes is lapsed and ii) room temperature is lower than set temperature -3°C (thermo off) and iii) when room temperature has achieved setting temperature -1°C then maximum Cool Dashed time will be revised to 20 minutes. And iv) indoor fan is set to Lo and Med fan mode and v) change operation mode.
- (3) During Cool Dashed operation, thermo off temperature is set temperature (with shift value) -3°C . After thermo off, operation continue in Fuzzy control mode.
- (4) Compressor minimum "ON" time and "OFF" time is 3 minutes.
- (5) During normal cooling mode, compressor maximum rpm CMAX will maintain for 60 minutes if indoor temperature is lower than CLMXTP. No time constrain if indoor temperature is higher than CLMXTP.
- (6) When fan is set to "Hi", compressor rpm will be limited to CSTD.
- (7) When fan is set to "Med", compressor rpm will be limited to CJKMAX.
- (8) When fan is set to "Lo", compressor rpm will be limited to CBEMAX.
- (9) During Cool Dashed, when room temperature reaches set temperature -1°C compressor rpm is actual rpm x DWNRATEC.

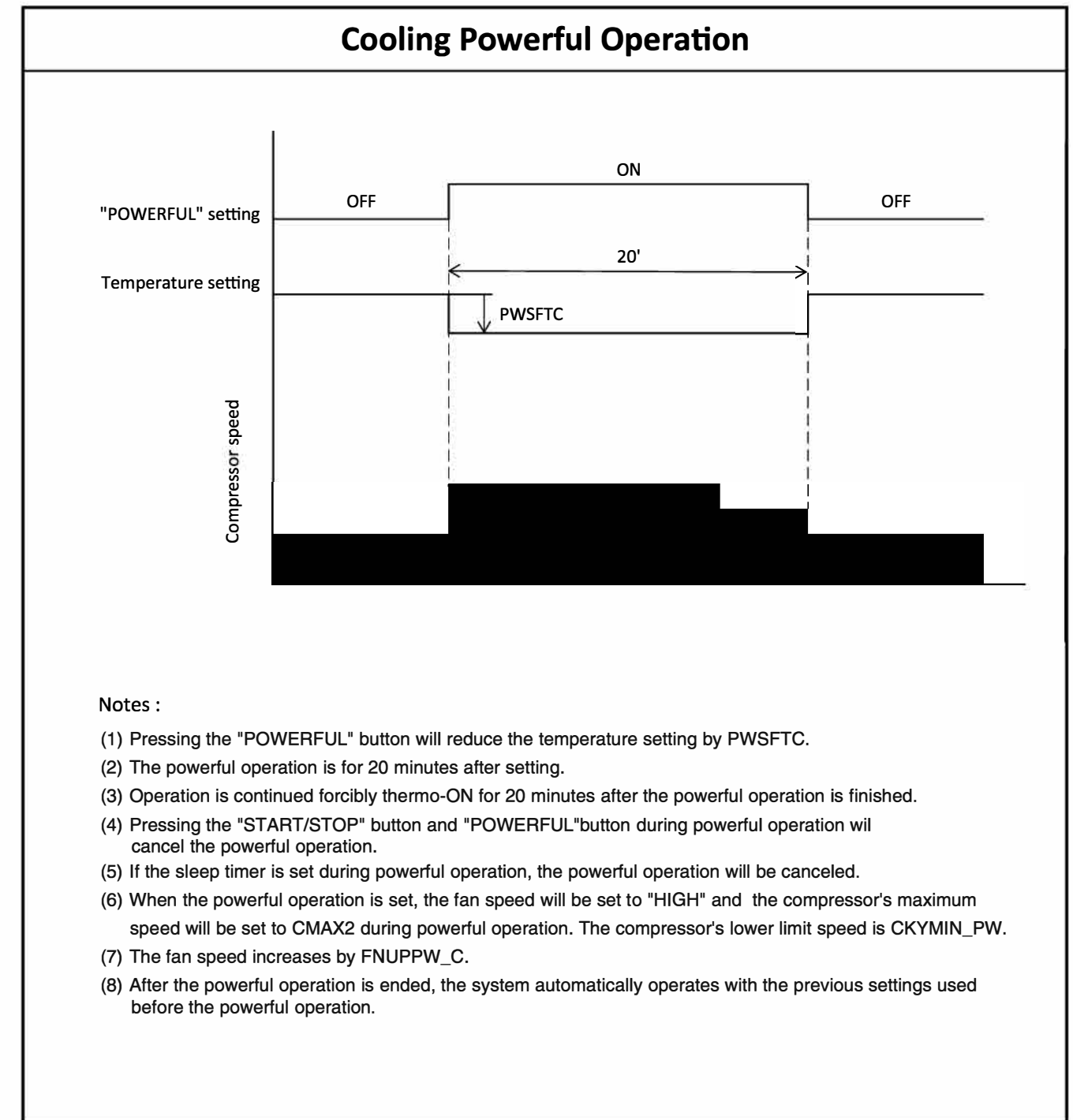
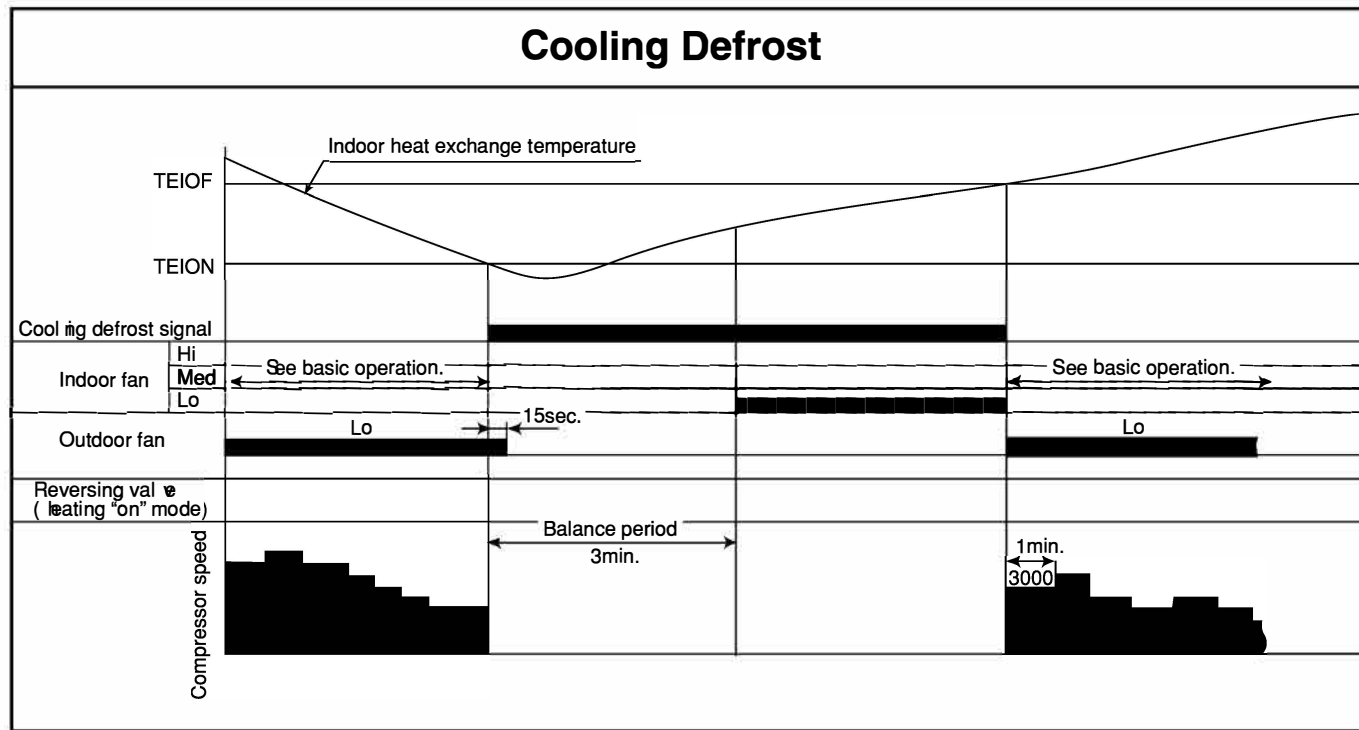

Notes :

- (1) Pressing the "POWERFUL" button will reduce the temperature setting by PWSFTC.
- (2) The powerful operation is for 20 minutes after setting.
- (3) Operation is continued forcibly thermo-ON for 20 minutes after the powerful operation is finished.
- (4) Pressing the "START/STOP" button and "POWERFUL" button during powerful operation will cancel the powerful operation.
- (5) If the sleep timer is set during powerful operation, the powerful operation will be canceled.
- (6) When the powerful operation is set, the fan speed will be set to "HIGH" and the compressor's maximum speed will be set to CMAX2 during powerful operation. The compressor's lower limit speed is CKYMIN_PW.
- (7) The fan speed increases by FNUPPW_C.
- (8) After the powerful operation is ended, the system automatically operates with the previous settings used before the powerful operation.

Dehumidifying

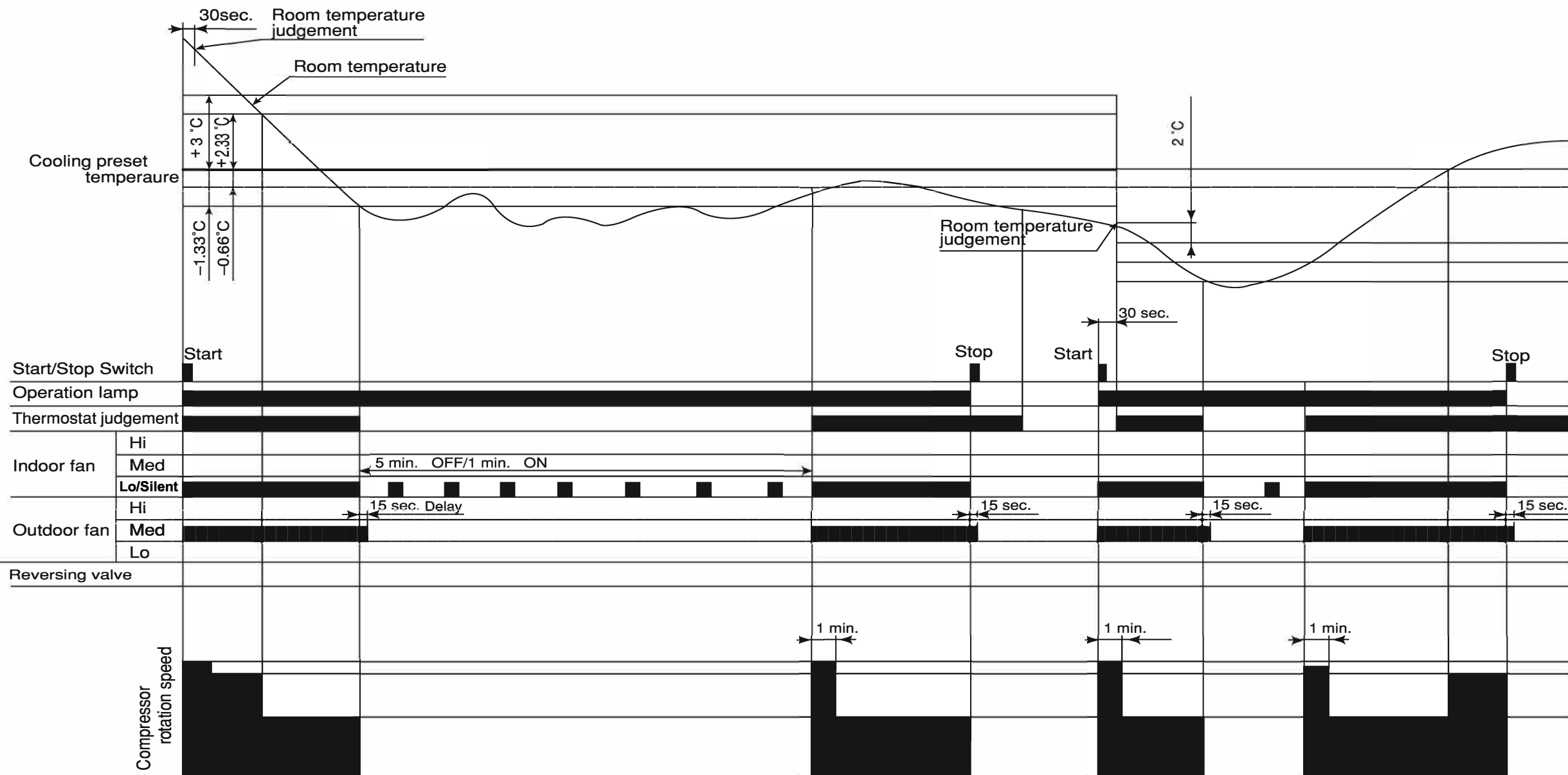

Notes:

- (1) If the room temperature is (cooling preset temperature) - (1.33°C) or less after 30 seconds from starting the operation, the operation is done assuming as the preset temperature = (room temperature at the time) - (2°C) .
- (2) The indoor fan is operated in the "Lo" or "Silent" mode. During thermo OFF, indoor fan will be OFF 5 minutes and ON for 1 minute
- (3) When the operation is started by the thermostat turning ON, the start of the indoor fan is delayed 32 seconds after the start of compressor operation.
- (4) The compressor is operated forcedly for 3 minutes after operation is started.
- (5) The minimum ON time and OFF time of the compressor are 3 minutes.

Dehumidifying Powerful Operation

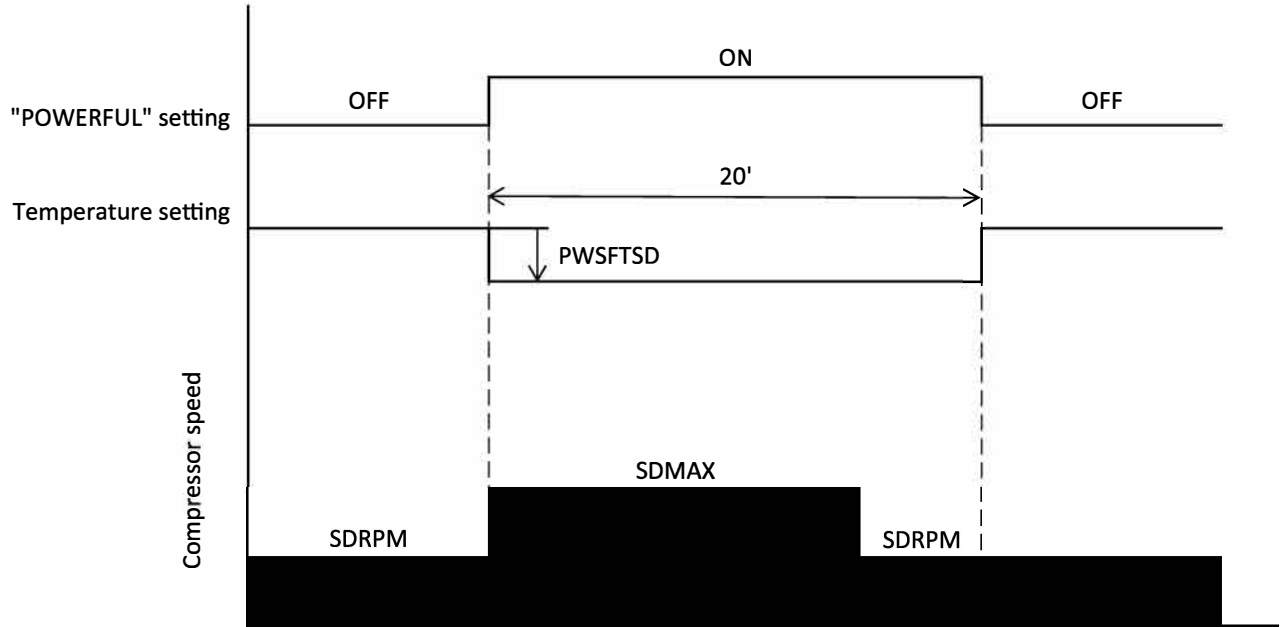

Notes :

- (1) Pressing the "POWERFUL" button will reduce the temperature setting by PWSFTSD.
- (2) The powerful operation is for 20 minutes after setting.
- (3) Operation is continued forcibly thermo-ON for 20 minutes after the powerful operation is finished.
- (4) Pressing the "START/STOP" button and "POWERFUL" button during powerful operation will cancel the powerful operation.
- (5) If the sleep timer is set during powerful operation, the powerful operation will be canceled.
- (6) If the differential (the room temperature - the temperature setting) is "the differential $\geq 3\text{ }^{\circ}\text{C}$ " after powerful setting, the compressor's maximum speed during powerful operation will be set to SDMAX. Then the differential reduce "the differential $\cong 2.33\text{ }^{\circ}\text{C}$ " during powerful operation, the compressor's speed will be set to SDRPM.
If the differential (the room temperature - the temperature setting) is "the differential $< 3\text{ }^{\circ}\text{C}$ " after powerful setting, the compressor's minimum speed during powerful operation will be set to SDRPM.
- (7) After the powerful operation is ended, the system automatically operates with the previous settings used before the powerful operation.

Basic Heating Operation

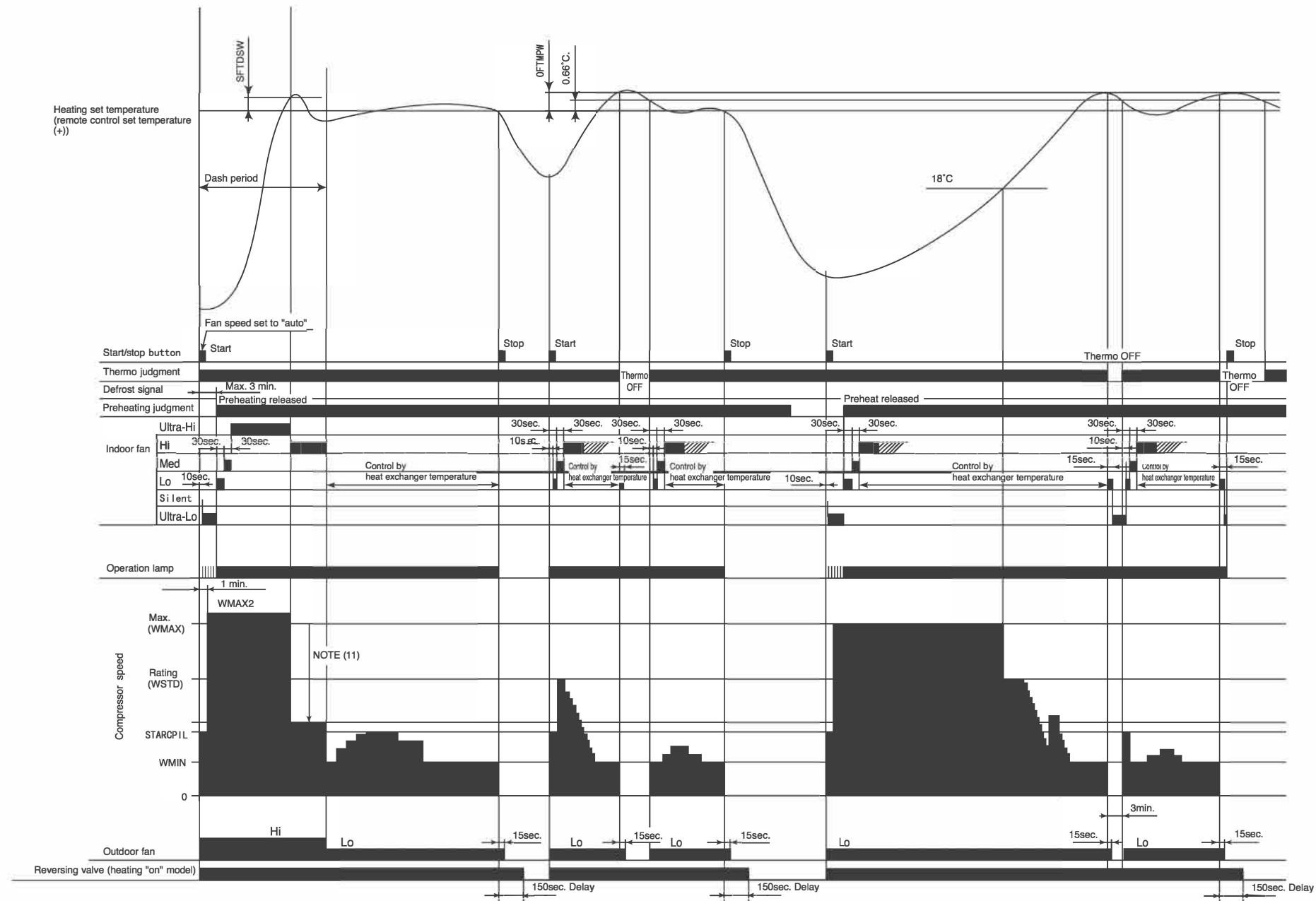

Notes:

- (1) Condition for entering into hot dashed mode. When fan set to "Hi" or "Auto" and i) room temperature is 18 or less, and ii) outdoor temperature is 10 or less, and iii) compressor speed (P section) due to temperature difference between setting temperature(including shift value only) and room temperature is WMAX or more.
- (2) The maximum compressor speed period during hot dash is finished when i) room temperature has reached the setting temperature + SFTDSW. ii) thermo off.
- (3) During hot dashed operation, thermo off temperature is setting temperature (with shift value) +3 . After thermo off, operation continue inn Fuzzy control mode.
- (4) Minimum "ON" time and minimum "OFF" time of compressor operation is 3 minutes.
- (5) During normal heating mode, compressor maximum rpm WMAX will maintain for 120 minutes. No time limit constrain if room temperature is 18 or less and outdoor temperature is 2 or less.
- (6) During preheating or defrosting or auto fresh defrosting mode, indoor unit operation lamp will blink at interval of 2 seconds "ON" and 1 second "OFF".
- (7) When heating mode starts, it will enter into preheating mode if indoor heat exchanger temperature is less than YNEOF + 0.33 .
- (8) When fan is set to "Med" or "Lo" or "Silent", compressor rpm will be limited to "WJKMAX" or "WBEMAX" or "WSZMAX".
- (9) During "Ultra-Lo" mode, heat exchanger temp 18 or less, indoor fan will stop. If hex temperature is 18 + 0.33 or more, fan will continue in "Ultra-Lo" mode. However, "Ultra-Lo" mode during preheating or preheating after defrosting does not stop if room temperature is 18 or less.
- (10) During hot dashed or outdoor temperature is -5 or less, compressor rpm is WMAX2.
- (11) During hot dashed, when room temperature reaches setting temperature + SFTDSW compressor rpm is actual rpm x DWNRATEW.

Reversing valve defrosting

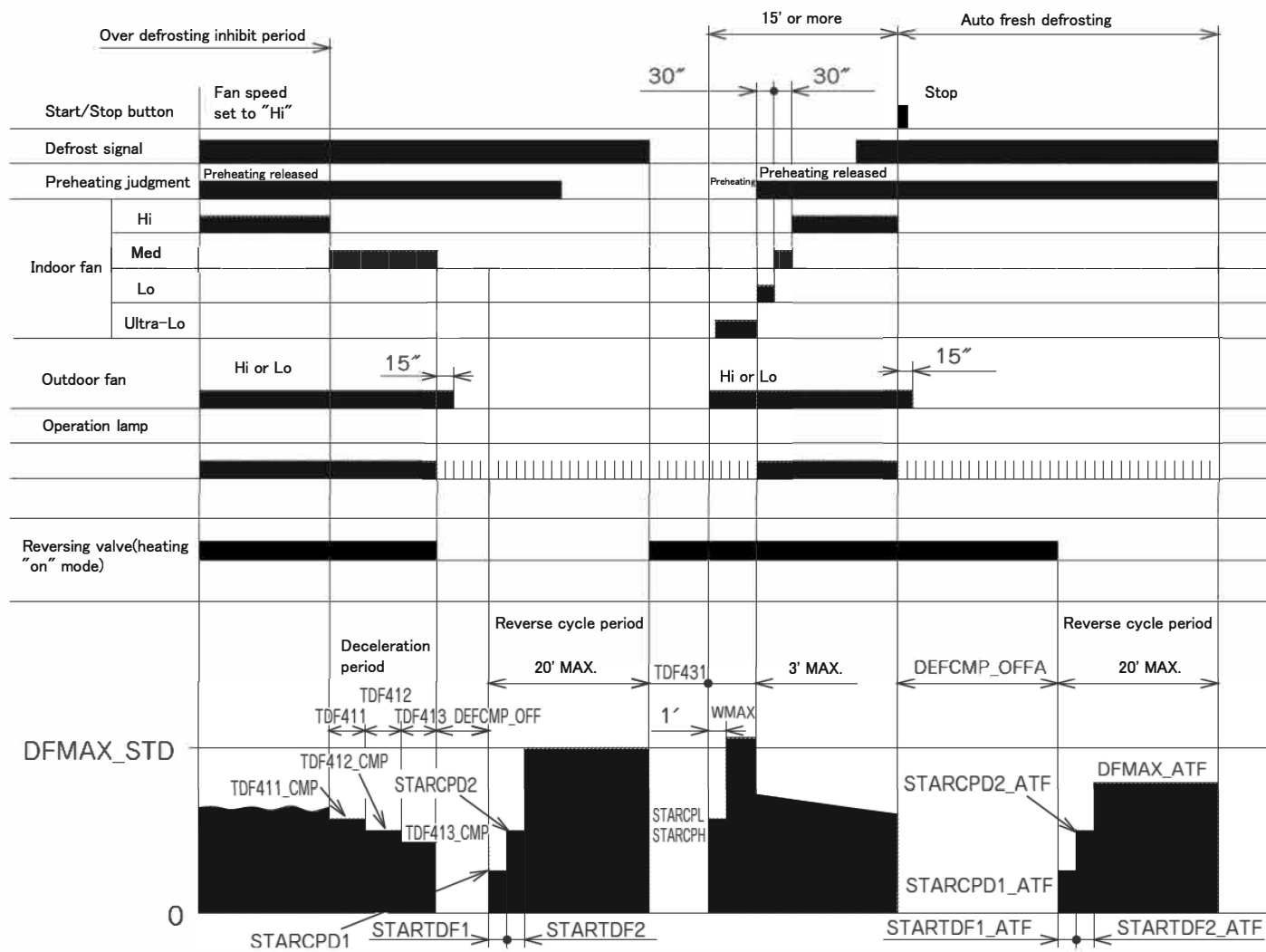

Notes:

- (1) The defrosting inhibit period is set as shown in the diagram below. When defrosting has finished once, the inhibit period is newly set, based on the outdoor temperature when the compressor was started. During this period, the defrost signal is not accepted.
- (2) If the difference between the room and outdoor temperature is large when defrosting is finished, the maximum compressor speed (WMAX) or (WMAX2) can be continued for 120 minutes maximum.
- (3) The defrosting period is 20minutes maximum.
- (4) When operation is stopped during defrosting, it is switched to auto refresh defrosting.
- (5) Auto refresh defrosting cannot be engaged within 15 minutes after operation is started or defrosting is finished.

Setting Defrosting Inhibit Period

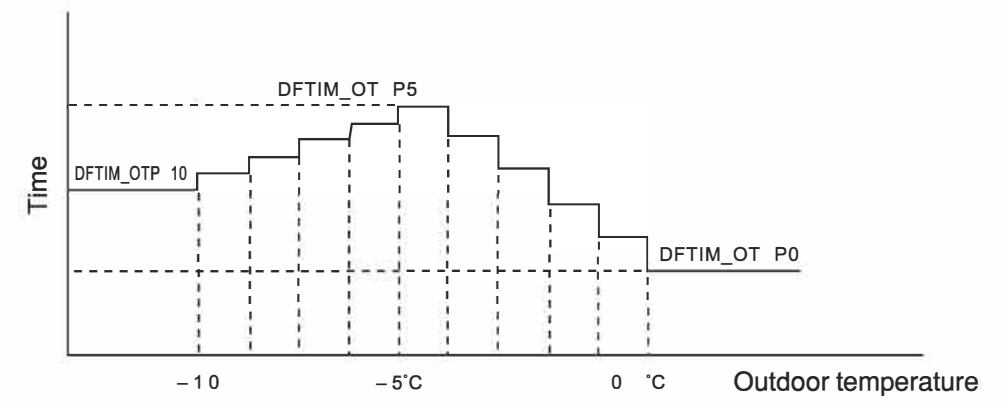

Notes:

- (1) The first inhibit time after operation start is set to DFTIM_FST.
- (2) From the second time onwards, the inhibit time is set according to the time required for defrosting.
Reverse cycle operation time \geq [DEFCOL] : DEFTIM_COL is set.
Reverse cycle operation time $<$ [DEFCOL] : The time corresponding to outdoor temperature is set.

Heating Powerful Operation

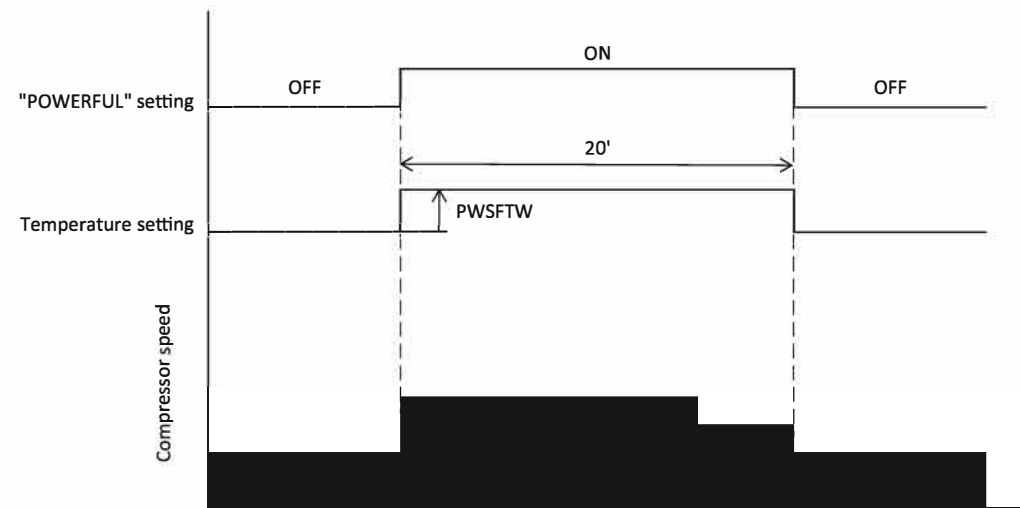

Notes :

- (1) Pressing the "POWERFUL" button will increase the temperature setting by PWSFTW.
- (2) The powerful operation is for 20 minutes after setting.
- (3) Operation is continued forcibly thermo-ON for 20 minutes after the powerful operation is finished.
- (4) Defrost is inhibited for 20 minutes after the start of the powerful operation.
- (5) Pressing the "START/STOP" button and "POWERFUL" button during powerful operation will cancel the powerful operation.
- (6) If the sleep timer is set during powerful operation, the powerful operation will be canceled.
- (7) When the powerful operation is set, the fan speed will be set to "HIGH" and the compressor's maximum speed will be set to WMAX2 during powerful operation. The compressor's lower limit speed is WKYMIN_PW.
- (8) After the powerful operation is ended, the system automatically operates with the previous settings used before the powerful operation.

Leave Home

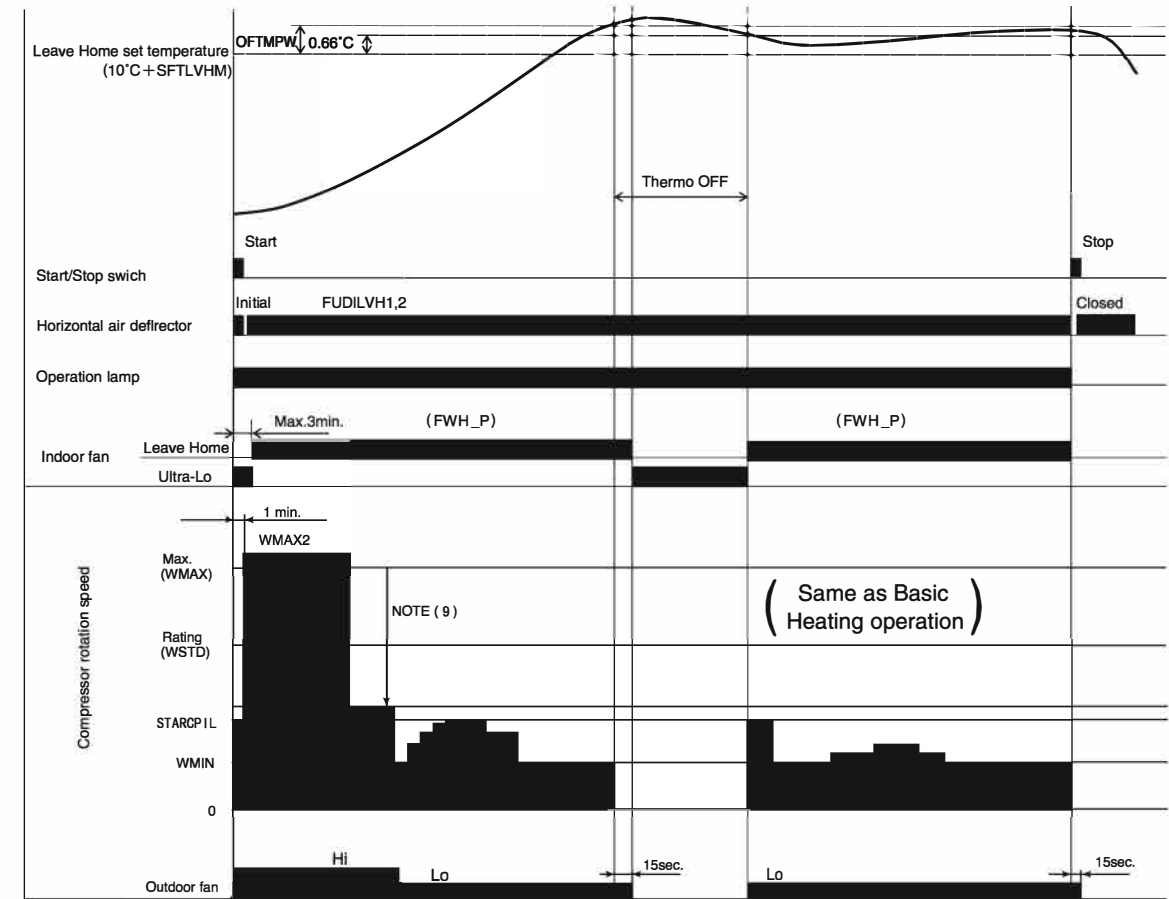

Notes:

Perform Leave Home operation according to the following control contents.

- (1) Operation mode : Heating
- (2) Setting temperature : 10°C
- (3) Shift value : + SFTLVHM
- (4) Indoor fan speed : FWH_P
- (5) Outdoor fan speed :
- (6) Compressor start control: } Same as Basic Heating operation
- (7) Compressor speed :
- (8) Operation lamp : ON

ECO

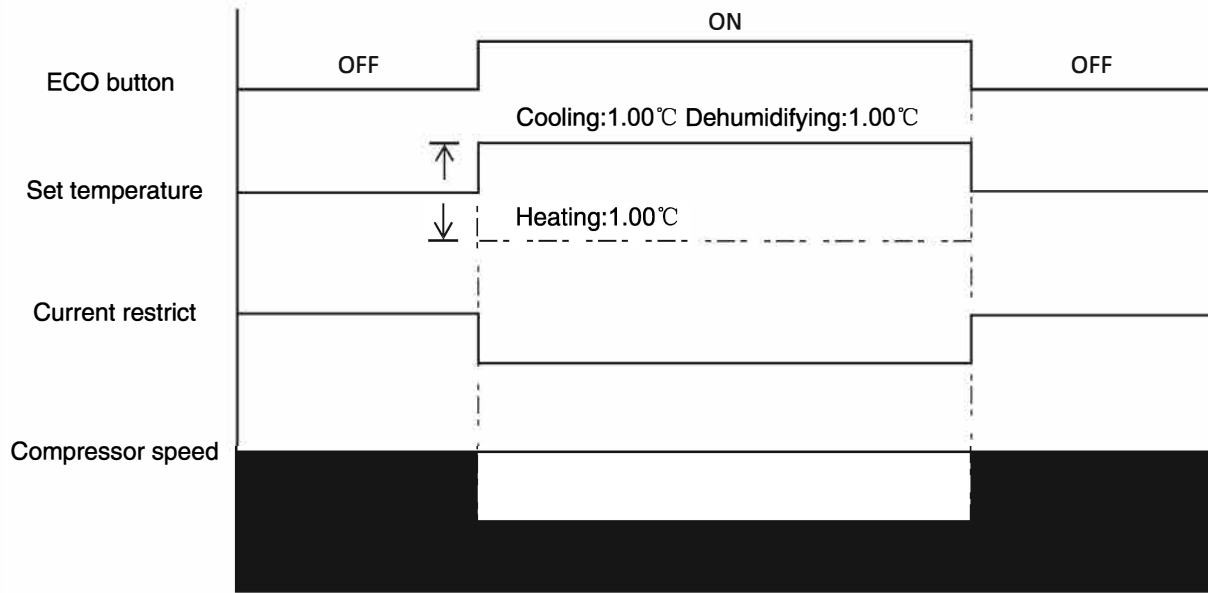

Notes:

- Can't set POWERFUL and ECO at the same time.
- During FAN operation, can't set ECO.

Clean Operation

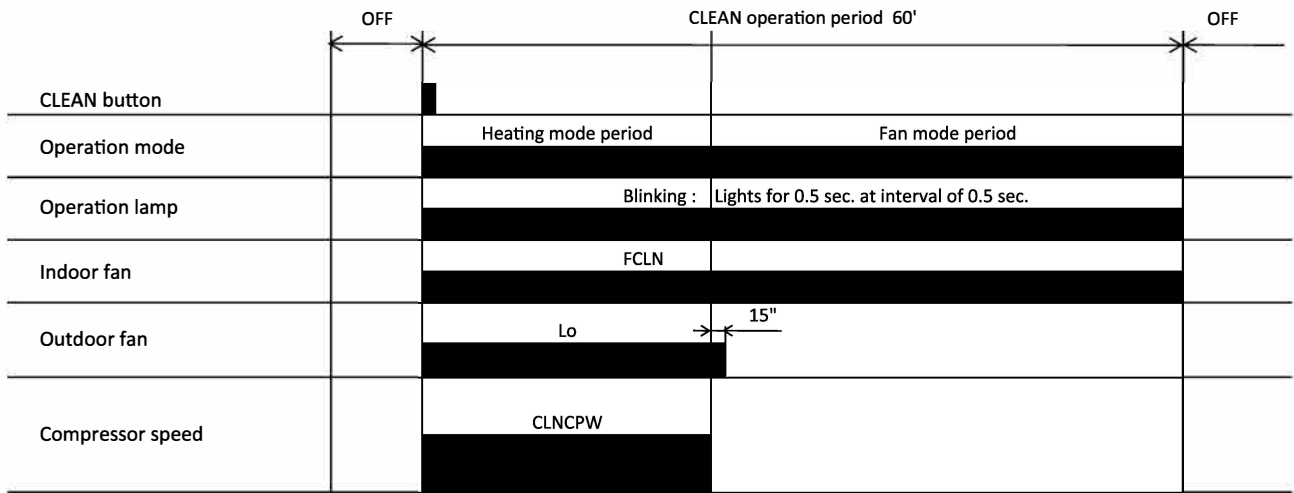

Notes :

- (1) During CLEAN operation period, heating mode will change to fan mode when HEX temperature is "CLNEVP" or more except for 3 minutes operation.
- (2) For multi connections, CLEAN operation is limited to fan mode.

REFRIGERATING CYCLE DIAGRAM

MODEL : RAS-EH36PHLAE / RAC-EH 36WHLAE

COOLING, DEHUMIDIFYING, DEFROSTING

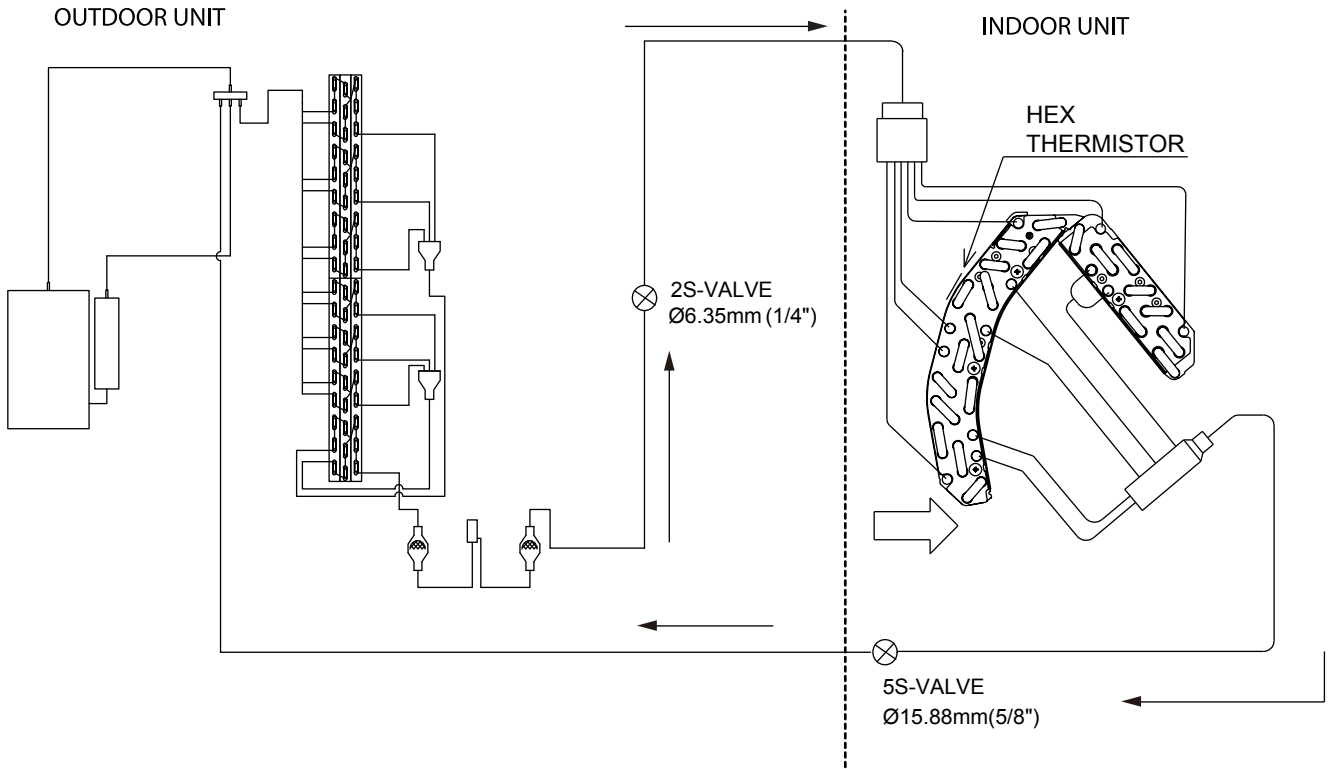

HEATING

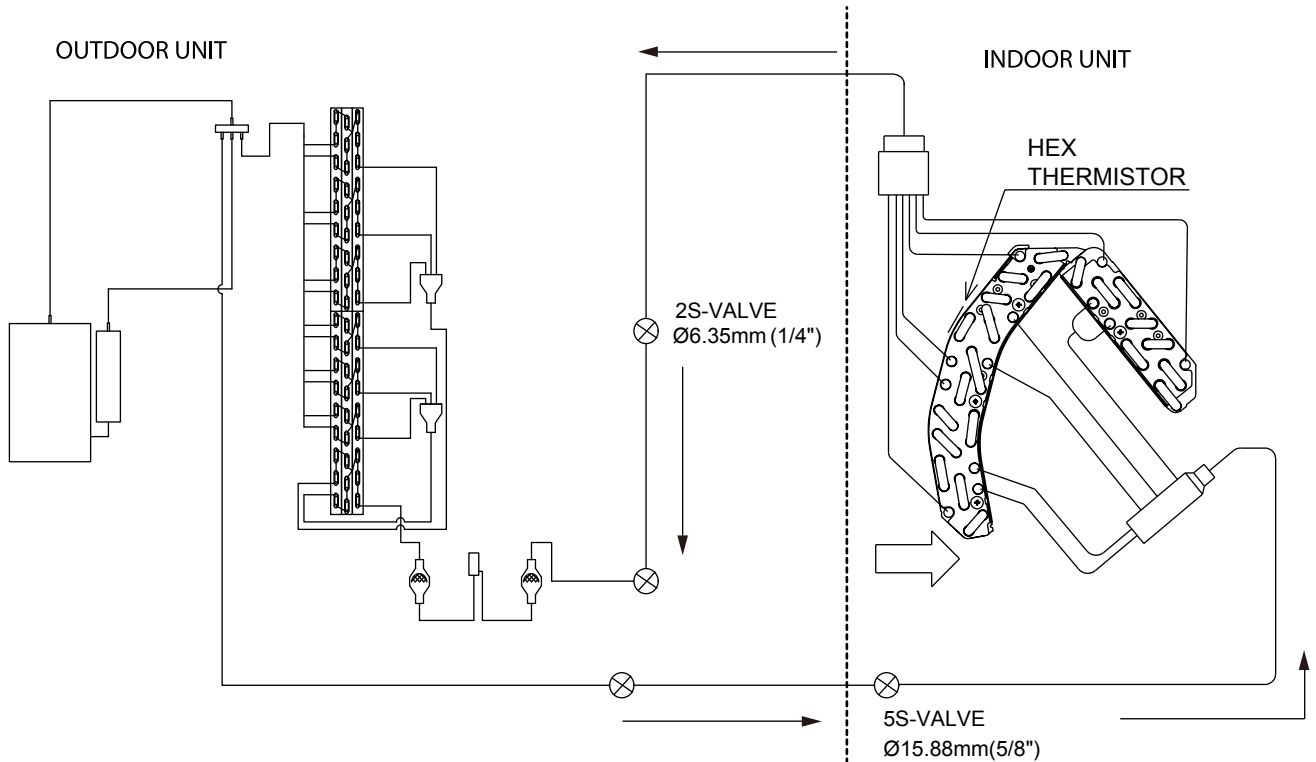

AUTO SWING FUNCTION

INPUT SIGNAL	PRESENT CONDITION		OPERATING SPECIFICATION	REFERENCE
	OPERATION	OPERATION MODE AIR DEFLECTOR		
KEY INPUT	STOP	EACH MODE	ONE SWING (CLOSING AIR DEFLECTOR) ① DOWNWARD ② UPWARD	INITIALIZE AT NEXT OPERATION.
	DURING OPERATION	COOL DRY	STOP AT THE MOMENT. START SWINGING ① DOWNWARD ② UPWARD ③ DOWNWARD	
THERMO. ON (INTERNAL FAN ON)	DURING OPERATION	DRY	DURING ONE SWING	
THERMO. ON (INTERNAL FAN OFF)	DURING OPERATION	DRY	DURING SWINGING	
MAIN SWITCH ON	STOP	COOL DRY	TEMPORARY STOP	
MAIN SWITCH OFF	DURING OPERATION	EACH MODE	DURING SWINGING	STOP SWINGING TEMPORARILY. (SWING MODE IS CLEARED IF SWING COMMAND IS TRANSMITTED DURING TEMPORARY STOP.)
CHANGE OF OPERATION	DURING OPERATION	EACH MODE	INITIALIZE ① DOWNWARD ② UPWARD	INITIALIZE AT NEXT OPERATION.
	DURING OPERATION	EACH MODE	STOP DURING ONE SWING STOP DURING SWINGING DURING INITIALIZING STOP	INITIALIZE AT NEXT OPERATION.
			INITIALIZING CONDITION OF EACH MODE.	
			STOP SWINGING AND MODE BECOMES INITIALIZING CONDITION.	

DESCRIPTION OF MAIN CIRCUIT OPERATION

MODEL: RAS-EH36PHLAE

1. Control power circuit

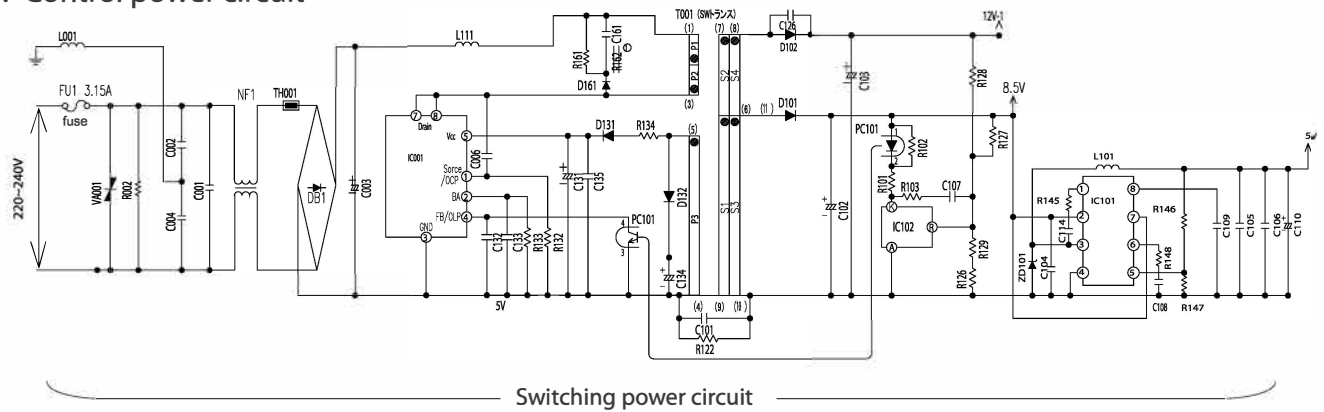

Fig.1-1

- An AC power supply from indoor unit passes through the 3.15A fuse, varistor (VA001), and noise filter circuit and rectified and smoothed by DB1 and C003 to become a DC current 325V. It is then supplied to indoor fan motor drive circuit, and switching power circuit.
- The switching power circuit, as controlled by IC001, drives the primary winding of the transformer (T001) to produce a specified voltage at the output winding. [The output terminal (pin ⑤) of IC001 has a switching voltage. But it changes in voltage peak and oscillation period depending on the power load. usually, the oscillation frequency when the air condition operation is about 64.5 kHz. In the standby state, the oscillation frequency is lowered to a level as low as 64.5 kHz or so to reduce the standby power.]
- The outputs of the output windings of the transformer is rectified and smoothed to become DC voltages at primary 18.5 V, 12 V, and 8.5 V respectively. The primary 18.5 V is supplied to the drive circuit of the indoor fan motor, the 12 V is supplied to each vane motor and to the drive circuits of the cleaning unit driving motor and other equipment, and the 8.5 V is adjusted to a stable 5 V by IC101 and supplied to the microcomputer peripheral circuit.

Check

If a failure in a part or circuit has produced an abnormal current in the power supply, the 3.15A fuse will melt down to prevent further damage. If the 3.15A fuse melts down, check the indoor fan motor, switching electrical circuit, and other components and replace any defective part.

Check

If an abnormally high voltage is applied to the power supply, the 3.15A fuse and varistor (VA001) will prevent further damage. If a high voltage results in the 3.15A fuse melted down, the varistor (VA001) should have deteriorated and destroyed. Therefore replace it at the same time.

Caution

The primary circuit of the transformer (T001) has a voltage to ground. Guard against electric shocks.

2. Reset Circuit

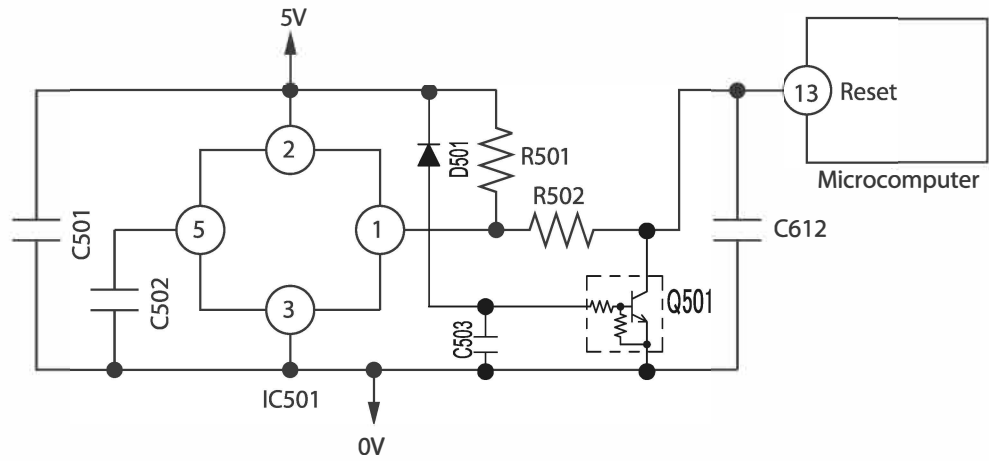

Fig. 3-1

Timing chart

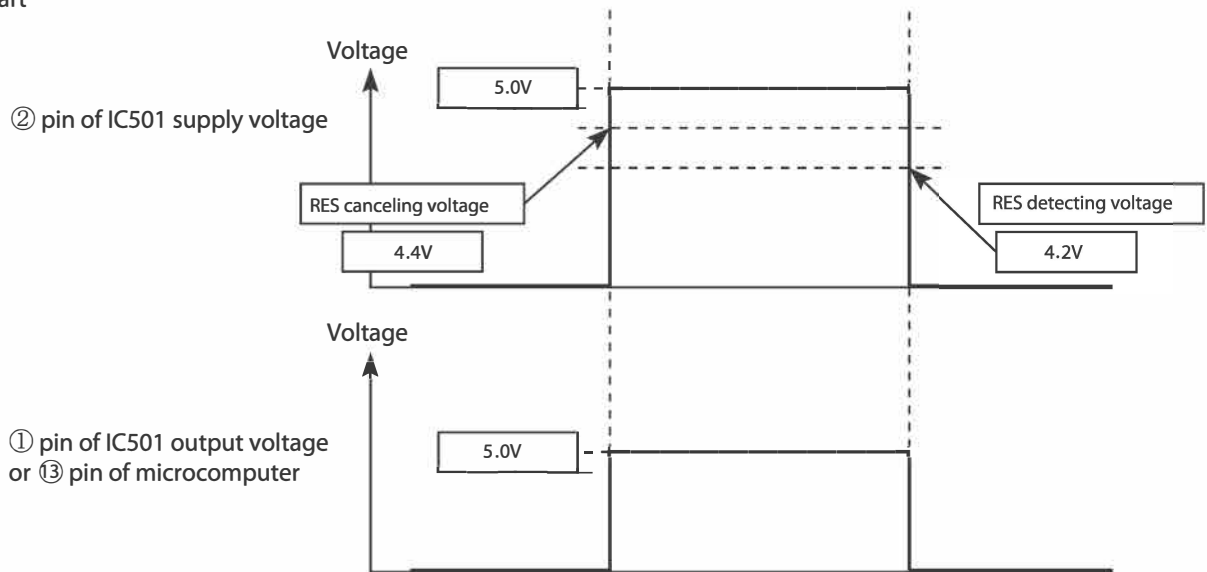

Fig. 3-2

- Reset circuit is to initialize the indoor unit microcomputer when switching ON the power or after recovering from power failure.
- Low voltage at pin ⑬ resets the microcomputer and Hi activates the microcomputer.
- Waveform of each part when switching ON the power and when shutting down is shown in the Fig. 3-2.
- After switching ON the power, ① pin of IC501 supply voltage and ⑬ pin of microcomputer becomes Hi when DC5V line rises and reaches approximately 4.4V or higher.
Then, resetting will be cancelled and microcomputer starts operating.
- After shutting down the power, ① pin of IC501 supply voltage and ⑬ pin of microcomputer becomes Lo when DC5V line falls and reaches approximately 4.2V or lower.
Then, the microcomputer will be in reset condition.

3. Drive circuit of the indoor fan motor

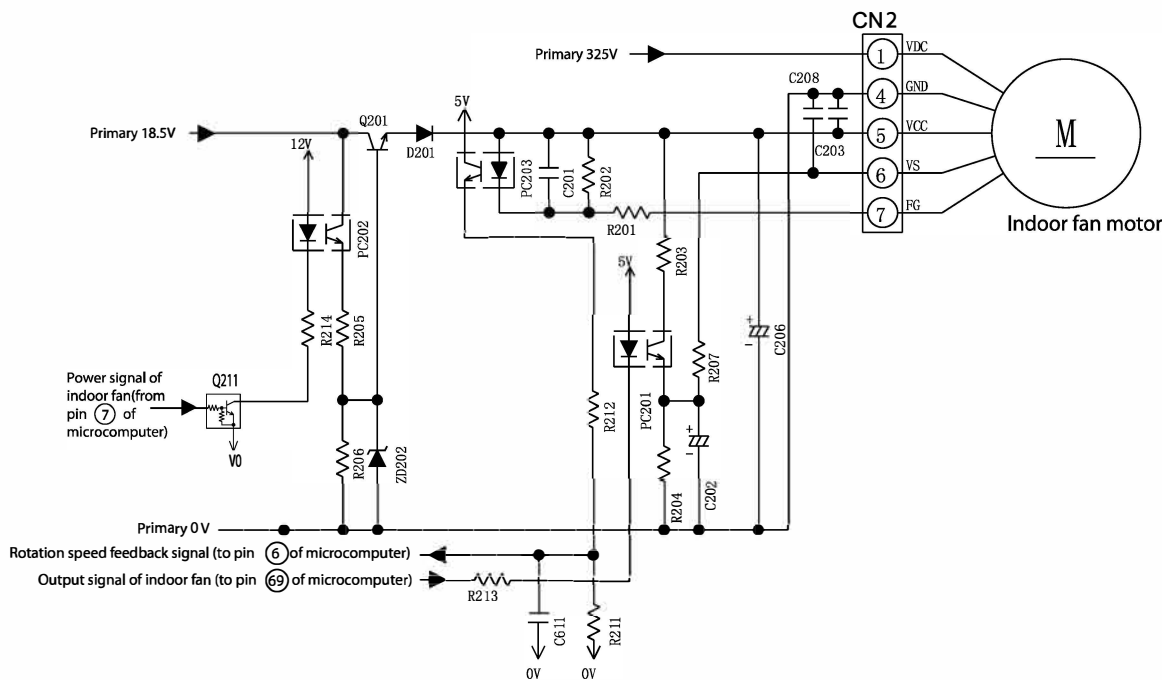
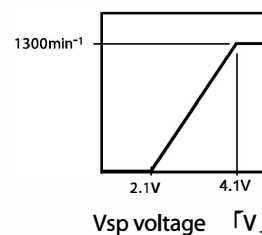

Fig. 3-1

< The circuit check (For test) >

Name	Test point	Test voltage
Motor drive power	CN2 ① pin- ④ pin	About 325V
Motor control power	CN2 ⑤ pin- ④ pin	About 15V
Motor speed signal	CN2 ⑥ pin- ④ pin	About 2-6V
Motor rotation speed debug	CN2 ⑦ pin- ④ pin	About 7.5V

< Pin 6 - Pin 4 voltage one example >



- * The voltage above is all motor operation vol. when you start the test, take care of your connector, do not touch the different pin together.
- * The voltage of pin ⑥ - pin ④, pin ⑦ - ④ maybe different from above.

* The different mode maybe have different FAN rotation speed.

< Typical circuit waveform >

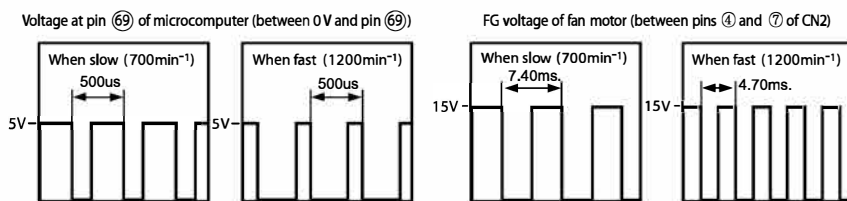

Fig. 3-2

- The indoor fan motor receives VDC (motor drive power supply), VCC (power supply for the control circuit inside the motor), and VS (speed command voltage) from CN2. The indoor fan motor returns an FG signal of a frequency that matches the rotation speed.
- VCC stabilizes the primary 18.5 V power supply into 15 V by using Q201 and supplies it.
- While on standby for a remote control signal, the Q201 shuts down the VCC and reduces the standby power.
- The VS receives a command voltage from the microcomputer. The VS terminal undergoes an analog voltage that matches the Lo level time ratio of the pulse signal from pin ⑥ of the microcomputer. (See Fig. 3-2.)
- The FG terminal undergoes a signal of 12 pulses per revolution of the motor shaft. By counting the pulse rate, the microcomputer recognizes the motor speed, thereby performing feedback control.

4. Buzzer Circuit

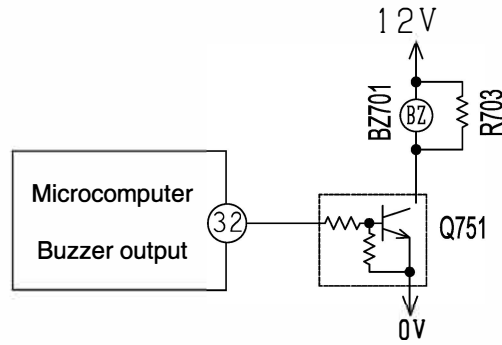

Fig.4-1 Buzzer Circuit

- When the buzzer sounds, an approx. 3.9kHz square signal is output from buzzer output pin (32) of the micro computer. After the amplitude of this signal has been set to 12Vp-p by a transistor, it is applied to the buzzer. The piezoelectric element in the buzzer oscillates to generate the buzzer's sound.

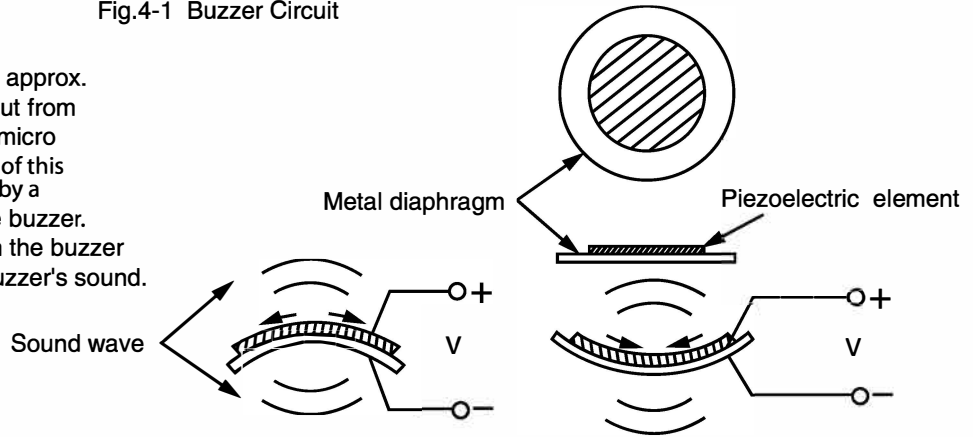

Fig.4-2 Buzzer Operation

5. Remote control reception circuit

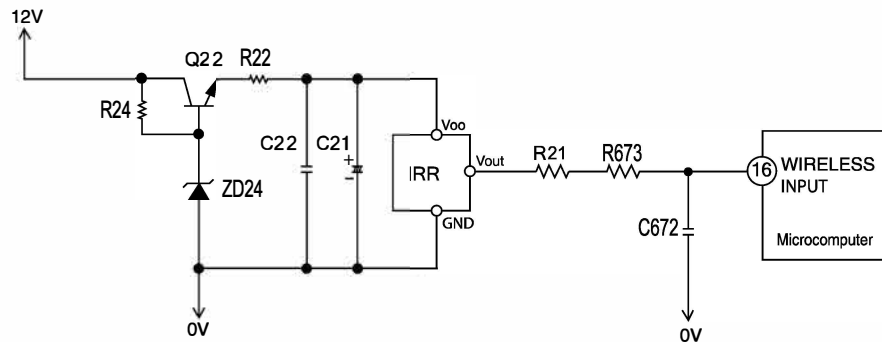

Fig.5-1

[Typical communication waveform]

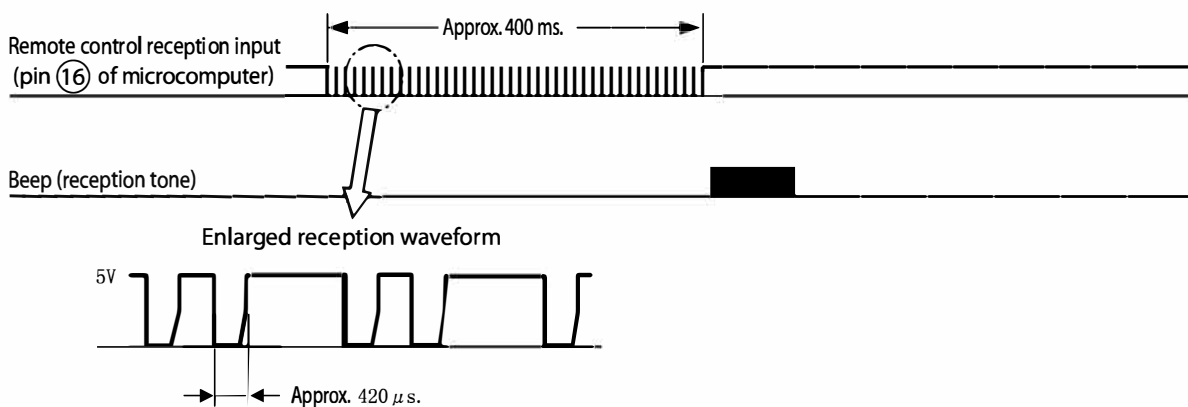
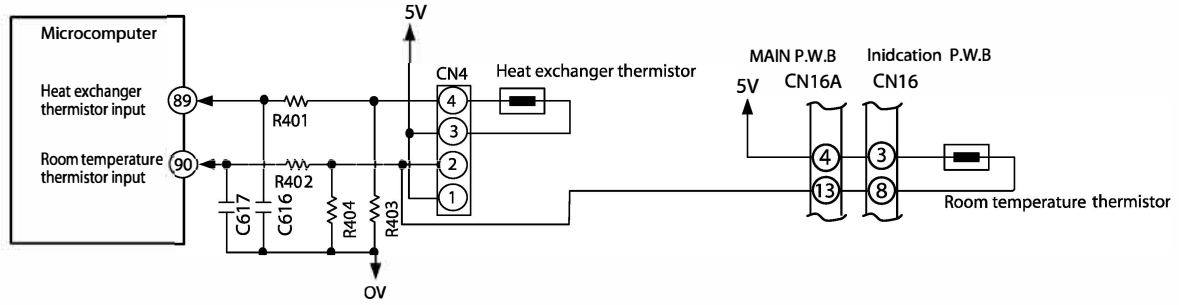

Fig. 5-2

- An infrared signal from the remote control unit is converted to an electrical signal by the remote control light-receiving unit and is received by the microcomputer. Data is transmitted as digital data 0 and 1 by changing the interval of the basic pulses at about 420 μs.

6. Room temperature, heat exchanger thermistor circuits



- The thermistor is used for detecting the room temperature and indoor unit heat exchanger pipe temperature.
- The thermistor is a sensor that changes its resistance value according to the temperature of the element and the microcomputer recognizes the analog voltage provided by the resistance voltage division with the fixed resistor as temperature signals.
- The relationship between the temperature of the thermistor and the circuit voltage is roughly as shown in Fig.6-1 and Fig.6-2. When it is easy to measure between the terminals of CN4 in actual measurement, use the graph of Fig. 6-3 "Thermistor both ends voltage".

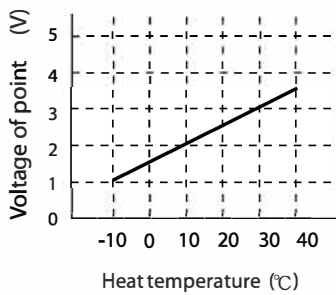

Fig. 6-1

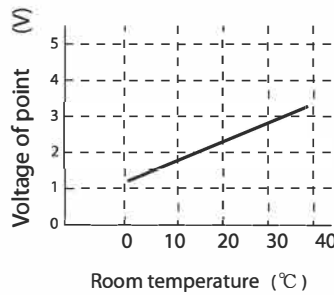

Fig. 6-2

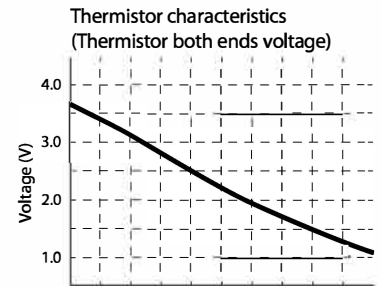

Fig. 6-3

7. Dip switch

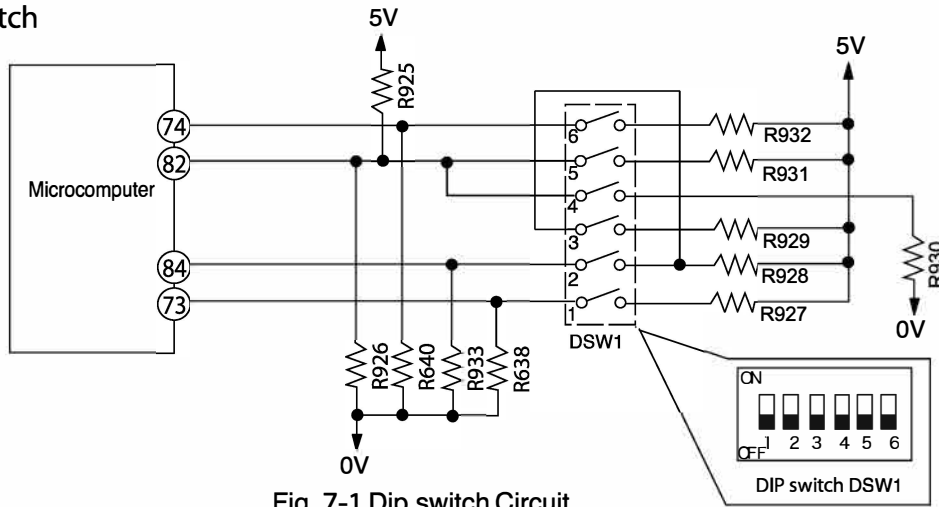

Fig. 7-1 Dip switch Circuit

- Fig. 7-1 shows the dip switch circuit; the table shown in Fig. 7-2 are function and setting position from ①-⑥ of the switch No.

SW No.	ITEM	FUNCTION			
1	AUTO RESTART	OFF*	ENABLE	ON	DISABLE
2	CARD KEY MODE	OFF*	DISABLE	ON	ENABLE
3	CARD KEY LOGIC SELECT	OFF*	INPUT HIGH ACTIVE	ON	INPUT LOW ACTIVE
4	HEATING/COOLING ONLY MODE SELECT	OFF*	HEATING & COOLING	OFF	HEATING ONLY
5	HEATING/COOLING ONLY MODE SELECT	OFF*		ON	
6	REMOCON ID SELECT	OFF*	FACTORY	ON	SELECT

Fig. 7-2 Functions of Dip switch

NOTE:

* Marking is position of shipping [FACTORY default setting]

8. Initial Setting Circuit (IC531)

- When power is supplied, the microcomputer reads the data in IC531 (E²PROM) and sets the preheating activation value and the rating and maximum speed of the compressor, etc. to their initial values.
- Data of self-diagnosis mode is stored in IC531; data will not be erased even when power is turned off.

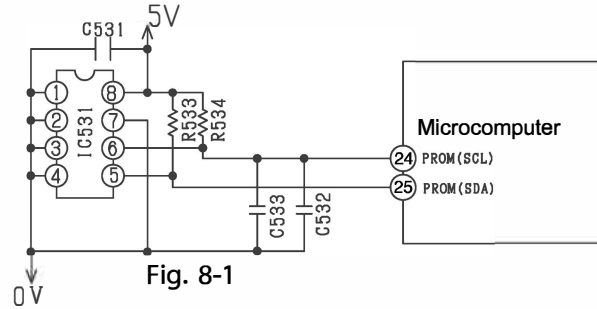

9. Temporary Switch Circuit

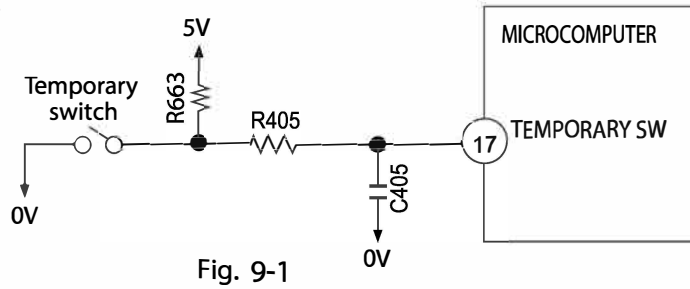

- The temporary switch is used to operate the air conditioner temporarily when the wireless remote control is lost or faulty.
- The air conditioner operates in the automatic mode by pressing the temporary switch. If the power switch is set to OFF then ON it also operates in the automatic mode when the temporary switch is pressed.

10. Indoor/outdoor communication circuits

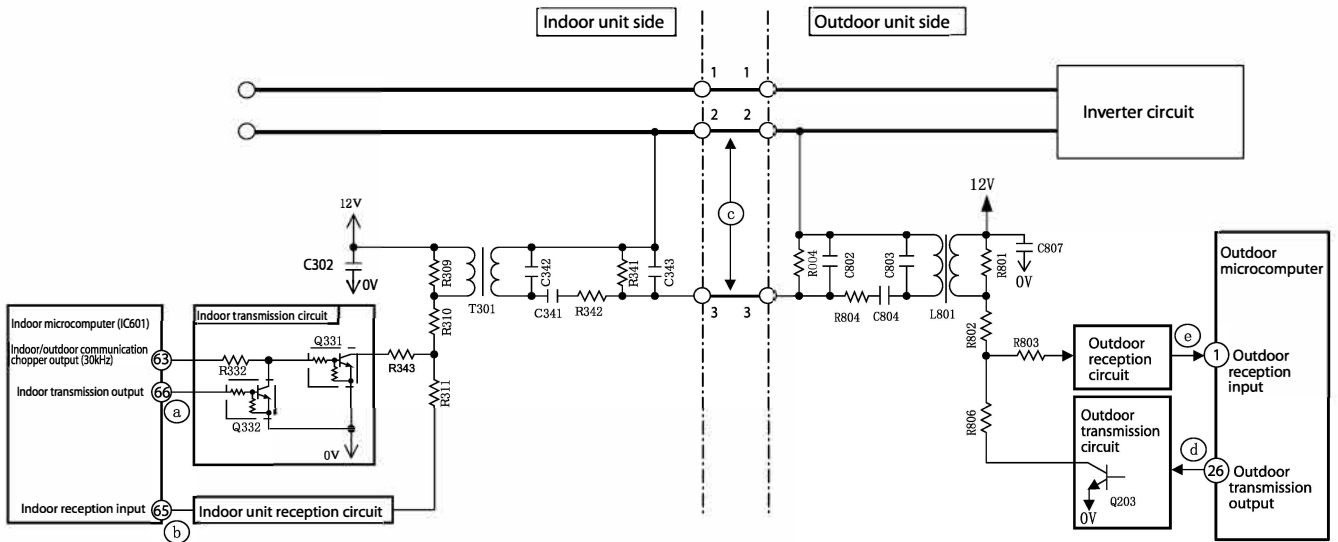

Fig. 10-1

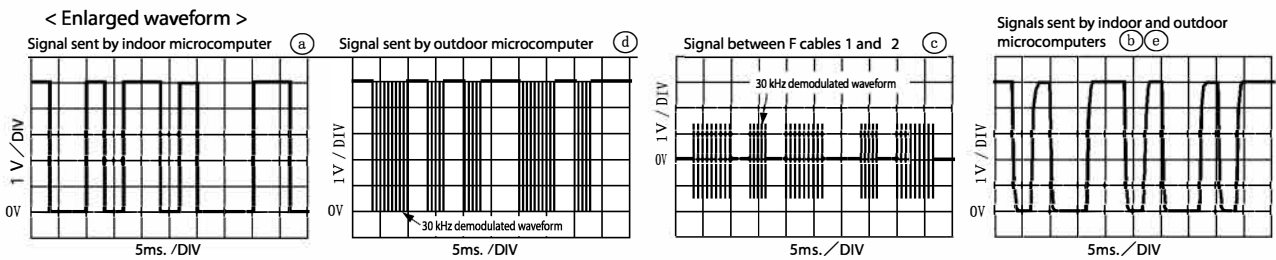
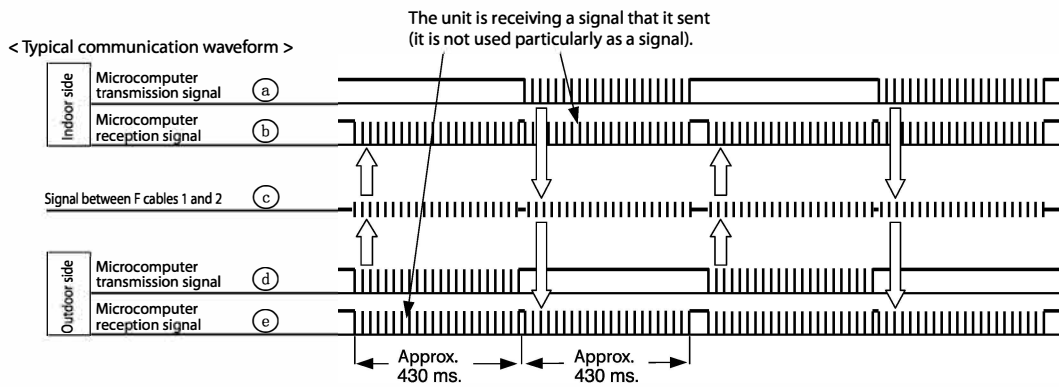

Fig. 10-2

- Indoor and outdoor communications are conducted by using lines 2 and 3 of F cable. Line 2 of F cable is shared with a transmission channel that powers the outdoor unit.
- Data communicated between the indoor and outdoor units are outputted from the microcomputer as serial signals and are transmitted as demodulated by a 30 kHz carrier wave. (Both the indoor and outdoor microcomputers directly output a signal demodulated at 30 kHz.)

Check

If a cable poorly inserted in the indoor terminal board or some other failure overheats the terminal board and the temperature fuse of the terminal board blows out, the power to the indoor communication circuit will be shut down to stop the communications function.

Check

If communication fails between the indoor and outdoor units for some reason, the product will give a self-diagnosis display either by "the timer lamp blinking 3 times" or "the timer lamp blinking 12 times" depending on the cause.

Indoor/Outdoor communication fault circuit judgement

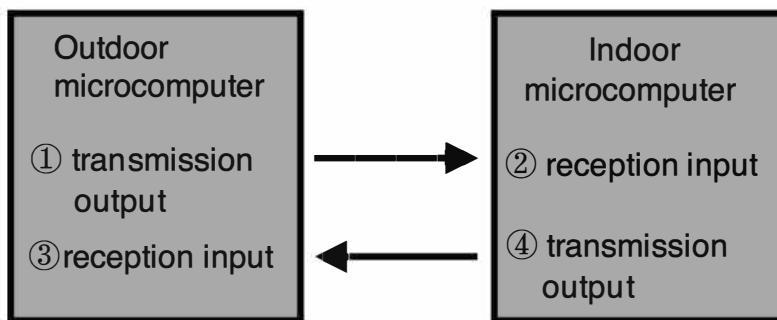

1. Failure happen during unit running

- 【If ① failure】 Outdoor: LD301 blinking 9 times / Indoor: no failure display
- 【If ② failure】 Outdoor: LD301 blinking 9 times / Indoor: the timer lamp blinking 3 times
- 【If ③ failure】 Outdoor: LD301 blinking 9 times / Indoor: no failure display
- 【If ④ failure】 Outdoor: LD301 blinking 9 times / Indoor: the timer lamp blinking 3 times

2. Failure happen during standby mode but outdoor unit not yet enter hibernation mode

- 【If ① failure】 Outdoor: LD301 blinking 9 times / Indoor: the timer lamp blinking 12 times
- 【If ② failure】 Outdoor: LD301 blinking 9 times / Indoor: the timer lamp blinking 3 times
- 【If ③ failure】 Outdoor: LD301 blinking 9 times / Indoor: the timer lamp blinking 12 times
- 【If ④ failure】 Outdoor: LD301 blinking 9 times / Indoor: the timer lamp blinking 3 times

3. Failure happen during standby mode but outdoor unit already enter hibernation mode

- 【If ① failure】 Outdoor: no failure display / Indoor: the timer lamp blinking 12 times
- 【If ② failure】 Outdoor: no failure display / Indoor: the timer lamp blinking 3 times
- 【If ③ failure】 Outdoor: no failure display / Indoor: the timer lamp blinking 12 times
- 【If ④ failure】 Outdoor: no failure display / Indoor: the timer lamp blinking 3 times

When outdoor unit is in hibernation mode, outdoor microcomputer is off, so the outdoor unit can't display the failure.

11. Stepping motor drive circuit

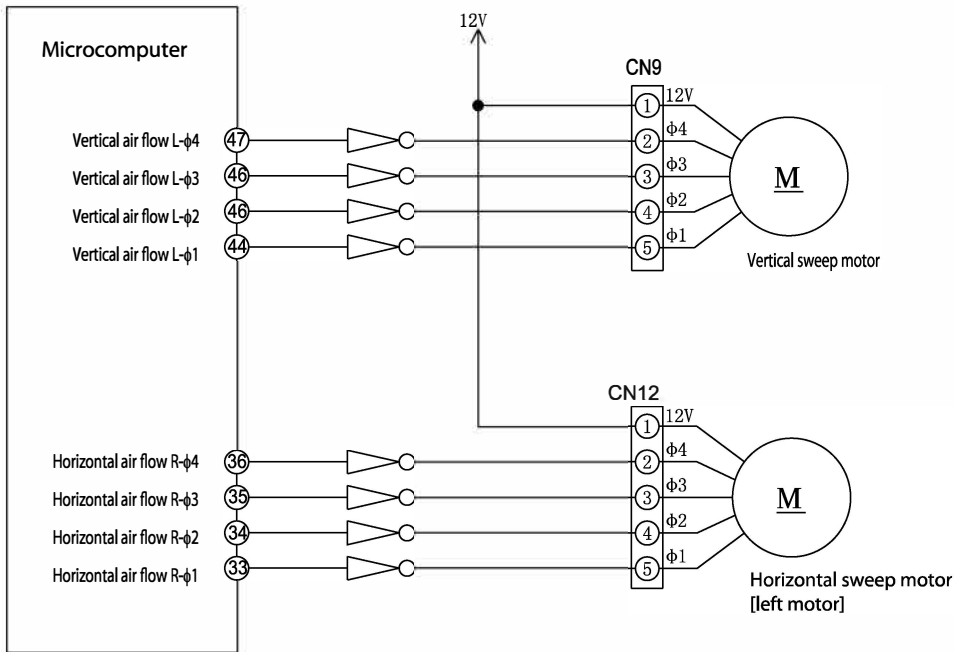

Fig. 11-1

[Connector circuit waveform while the motor runs]

Voltage waveforms of different phases as viewed from the OV line while the motor rotor is turning counterclockwise as viewed from the shaft side

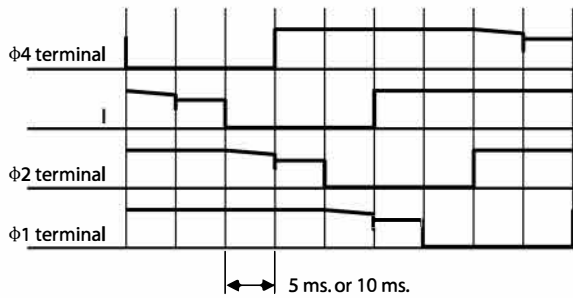

Fig. 11-2

- Each stepping motor runs as excited in 1 or 2 phases at 100 PPS or 200 PPS.
- The excitation pattern passes the microcomputer (IC601) and then the driver IC and excites the coil of each stepping motor.
- Some models not need to install the horizontal sweep motor.

12. Run status and alarm signal output circuit

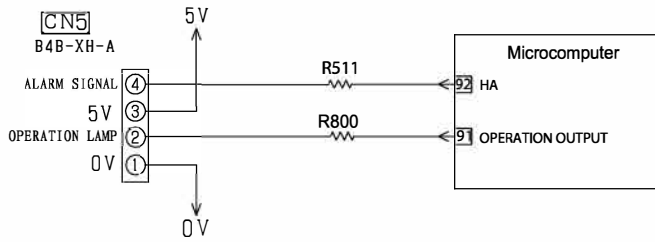

Fig.12-1

Fig.12-1 is the control circuit of run status and signal output in main PWB. The pin ② of CN5 is used to show run status and the pin ④ of CN5 is used to warn people when failure occurrence. If customer want to use this function, need to use the adapter (sold separately) to achieve it. the adapter is optional and the detail circuit refer to following circuit.

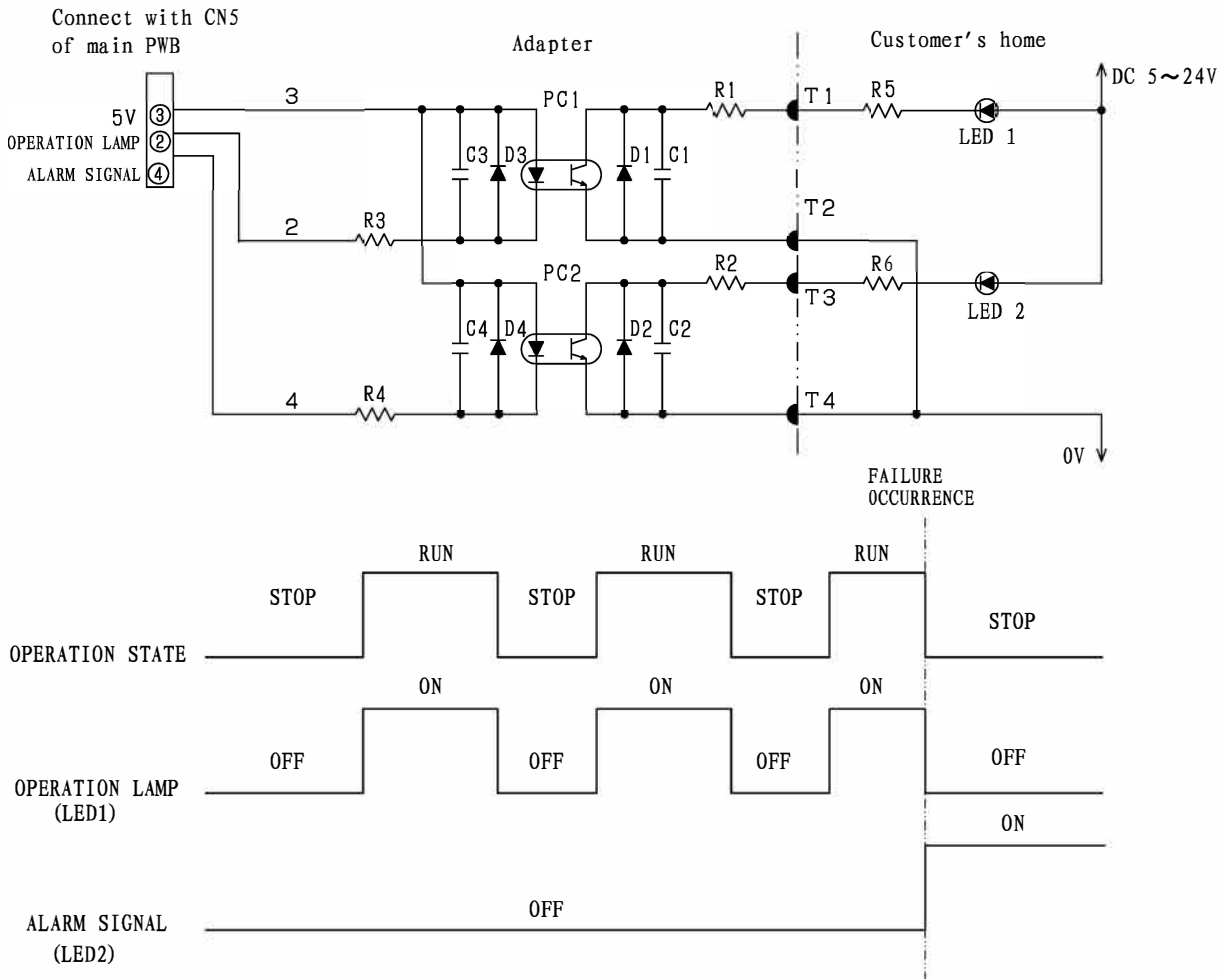

Fig.12-2

LED1 is on When air-condition is running and is off When air-condition is stopping. We can know the status of air-condition by LED1. LED2 is off When air-condition in normal condition and is on when air-condition in failure occurrence, we can repair it in time. The brightness of the lamp (LED1, LED2) can be determined by adjusting the resistance (R5, R6) value.

※ The adapter must to be used because of noise interference. The noise will cause air-condition failure. the voltage from customer's home supply to adapter must be in the 5~24V, the current is less than 10mA. If the voltage is lower than 5V, optocouplers will not be action; once the voltage is higher than 24V, optocouplers adapter will be damaged.

DESCRIPTION OF MAIN CIRCUIT OPERATION

MODEL : RAC-EH36WHLAE

1. Main Power Supply Circuit

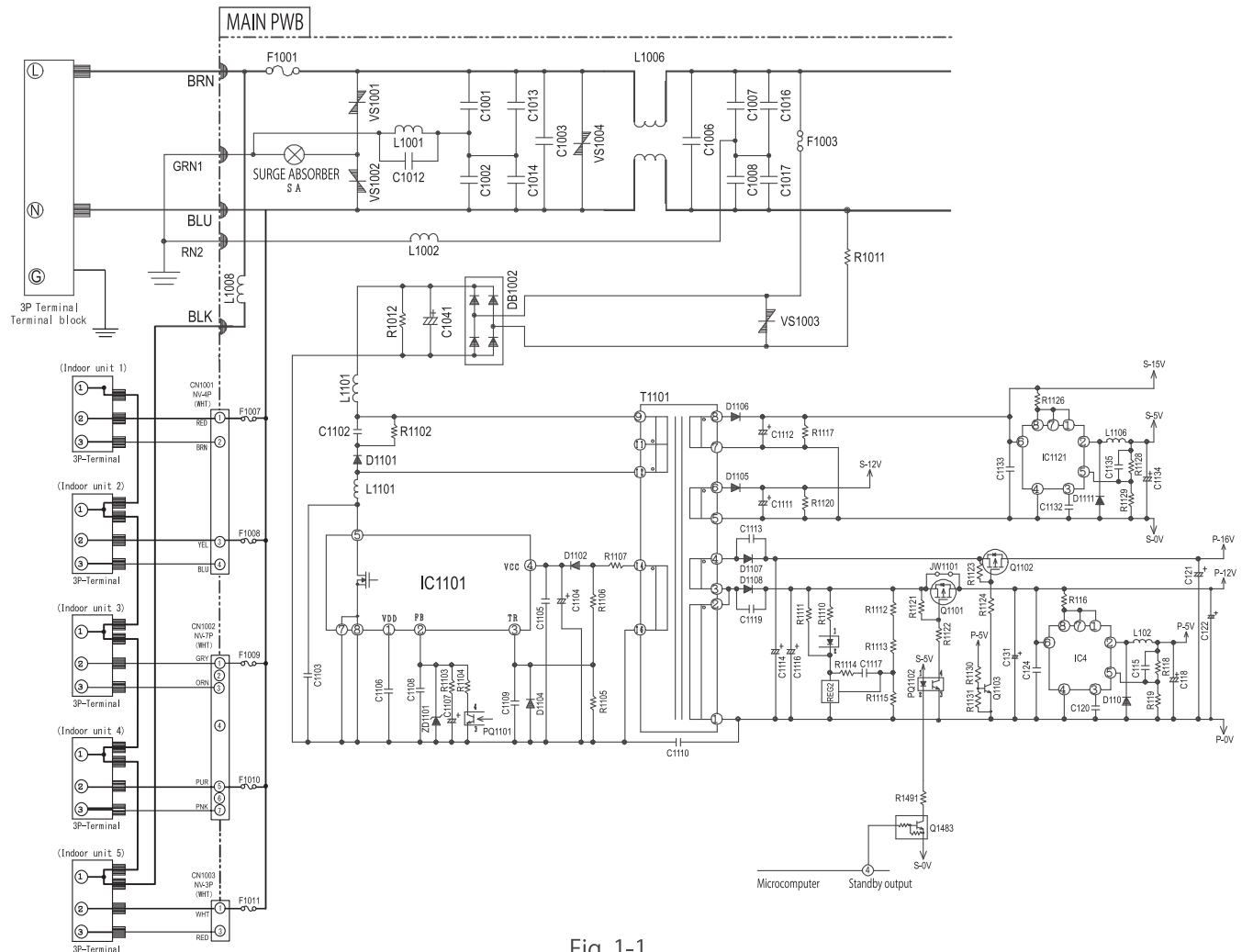

Fig. 1-1

- AC208-230V power supplied to the 3P terminal block is supplied to DB1002 via the noise filter circuit, 2A fuse (F1003), and varistor VS1003. High voltage DC smoothed by DB1002 and C1041 is used to create DC voltage on the transformer's secondary side by the switch control IC (IC1101) and switching transformer (T1101).
- Secondary side DC voltage is used in the following six systems:
 - (1) S-15V : Power supply for communication circuit between outdoor and indoor
 - (2) S-12V : Operating power supply for electric expansion valve
 - (3) S-5V : Power supply for main microcomputer and peripheral circuits
 - (4) P-16V : Power supply for compressor motor driver circuit and fan motor driver circuit
 - (5) P-12V : Power supply for reversing valve relay, power relay, in-rush current relay, and compressor motor operating amplification and fan motor current amplification.
 - (6) P-5V : Power supply for inverter microcomputer and peripheral circuits
- Primary Components
 - (1) C1001, C1002, C1013, C1014, C1003, C1006, C1007, C1008, C1016, C1017, L1006
Absorb electrical noise generated during operation of the compressor, and reduce noise level emitted to the power line.
 - (2) Surge absorber, VS1001, VS1002, VS1004, VS1003
Absorb external surges, such as induced lightning.
 - (3) IC1101
IC for control of switching power.
 - (4) IC4
DC/DC converter IC for generating P-12V and P-5V.
 - (5) IC1121
DC/DC converter IC for generating S-15V and S-5V.

- Inverter Microcomputer Power Control

The power to the inverter microcomputer is turned ON/OFF by commands from the main microcomputer, Q1483, PQ1102, Q1101, and Q1102 are related.

- Specifications and Checkpoints for Main Power Supply Circuits

Output Name	Voltage Specification	Primary Load	± Measurement Location	Examples of Possible Failure Modes for Output Failures (for Reference)
S-15V output	15.5 ±1.5 V	Indoor/outdoor communication	Tester ⊕ terminal: S-15V indicator (Main PWB : L1107) Tester ⊖ terminal: S-0V indicator (Main PWB : IC1035)	LD1401 ~ LD1402 (green) do not light or blink.
S-12V output	12 ^{+4,-2} V	Expansion valve	Tester ⊕ terminal: S-12V indicator (Main PWB : D1105) Tester ⊖ terminal: S-0V indicator (Main PWB : IC1035)	LD1351 (red) blinks 5 or 6 times (related to refrigerant cycle error) and stops.
S-5V output	5 ±0.4 V	Main microcomputer thermistor	Tester ⊕ terminal: S-5V indicator (Main PWB : L1108) Tester ⊖ terminal: S-0V indicator (Main PWB : IC1035)	LD1353 (green) does not blink. LD1351 (red) does not blink. Outdoor unit does not operate.
P-16V output	15.5 ±1.5 V	Compressor IPM DC fan drive circuit Converter circuit	Tester ⊕ terminal: P-16V indicator (Main PWB : Q1102), (Inverter PWB : P-16V test point) Tester ⊖ terminal: P-0V indicator (Main PWB : PQ1102), (Inverter PWB : JW004)	LD1351 blinks 3, 4 or 12 times and then stops.
P-12V output	12 ±1 V	IC2, 3, 4, relay circuits	Tester ⊕ terminal: P-12V indicator (Main PWB : Q1101), (Inverter PWB : P-12V test point) Tester ⊖ terminal: P-0V indicator (Main PWB : PQ1102), (Inverter PWB : JW004)	LD1351 blinks 2, 4, 8 or 14 times and then stops.
P-5V output	5 ±0.4 V	Inverter microcomputer	Tester ⊕ terminal: P-5V indicator (Main PWB : PQ1811), (Inverter PWB : L105) Tester ⊖ terminal: P-0V indicator (Main PWB : PQ1102), (Inverter PWB : JW004)	LD1351 blinks 8 times.

- Check each voltage. If the above specifications are satisfied, the main power supply circuit can be considered normal.
- Due to high voltage, be particularly careful to avoid electric shock. Further, take care to avoid short-circuit accidents caused by incorrect connection of measuring instruments. Otherwise, the board could be damaged.
- Even after the power is turned off, an electric charge remains in the smoothing capacitor, and a voltage of 260V to 360V is applied between the terminals of the smoothing capacitor.

2. Converter Circuit

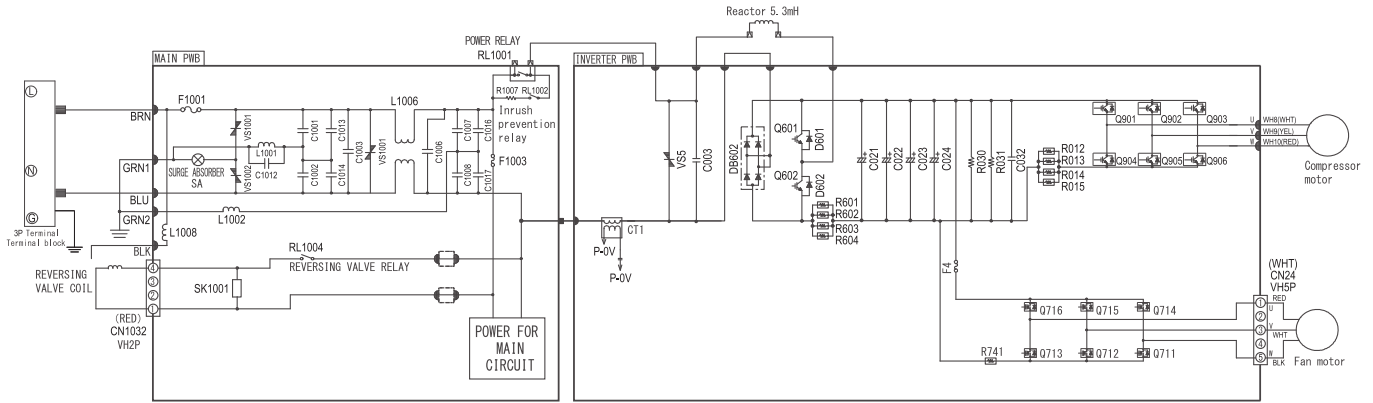

Fig. 2-1

- This circuit rectifies the AC208-230V between L and N on the 3P terminal block, and creates a DC voltage. During operation of the compressor, the rectified circuit voltage is approximately (DC320V - 360V).

- Primary Components

- (1) Q901, Q902, Q903, Q904, Q905, Q906 used for configuration of inverter section.

Reference:

- In case of Q901, Q902, Q903, Q904, Q905, Q906 failure or broken, immediately after starting the compressor, it might stop due to abnormal speed reduction, switching failure, Ip cut, etc.

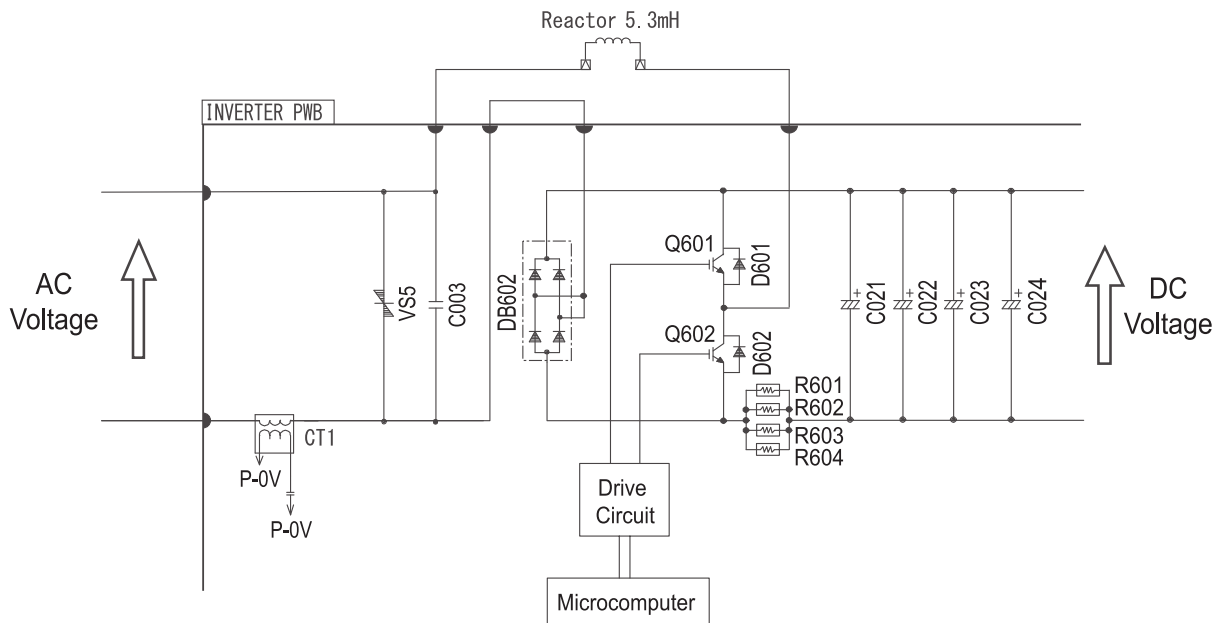

Fig. 2-2

(2) Smoothing Capacitor (C021~C024, 500 μ F 450V)

Boosts and smoothes (averages) DC voltage rectified by the DB602, Q601, Q602.

(3) Power supply rectification, power factor improvement element (DB602, Q601, Q602)

It works to rectify the AC voltage of 208-230V supplied from the terminal block to DC voltage.

Also, when the load on the compressor is rising, switching Q601 and Q602 performs power factor correction and boost.

Inspection when Timer Lamp on Indoor Unit Flashes Once

Note: Be sure to turn the power off before performing the following inspection.

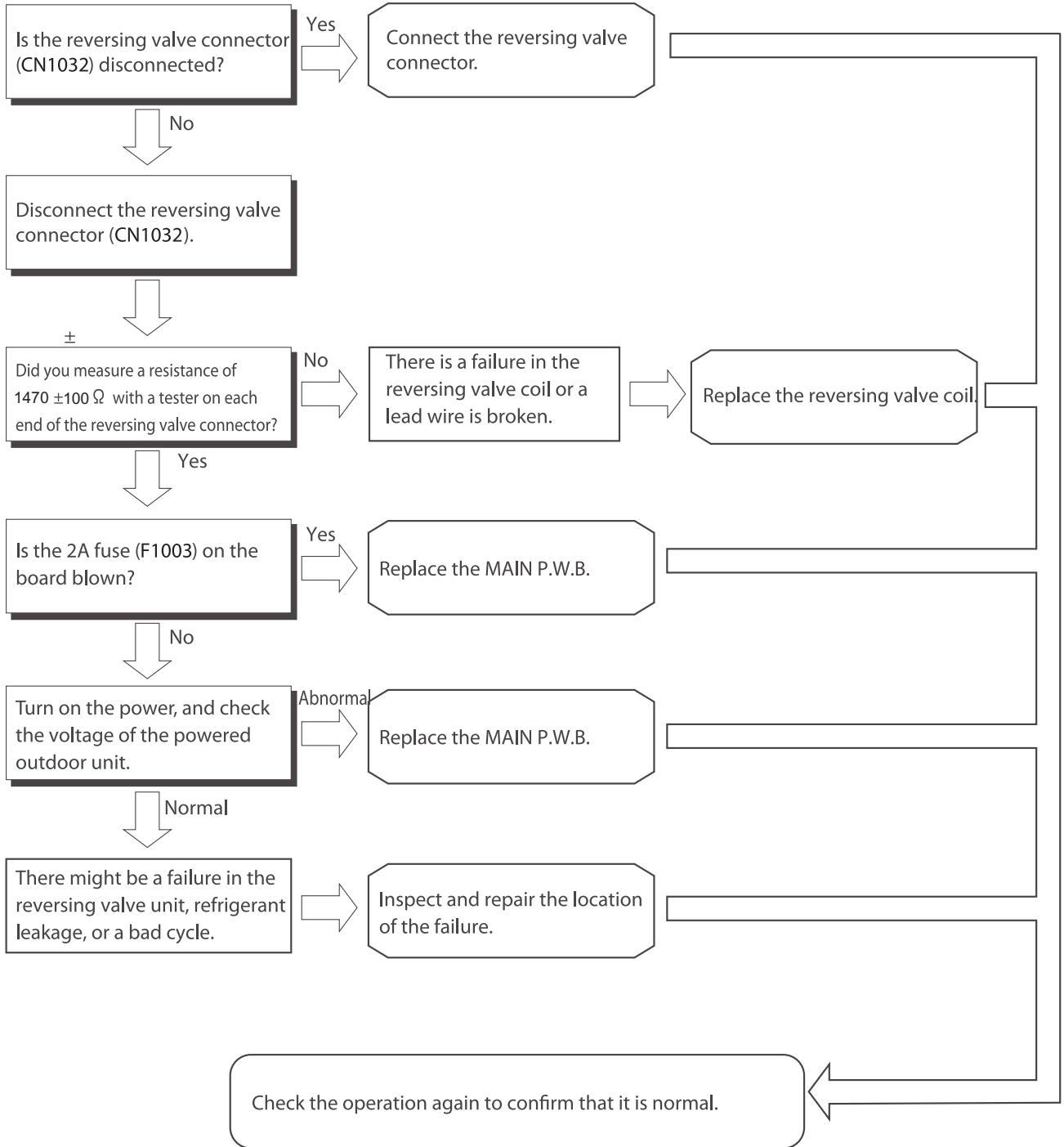

4. Temperature Detection Circuit

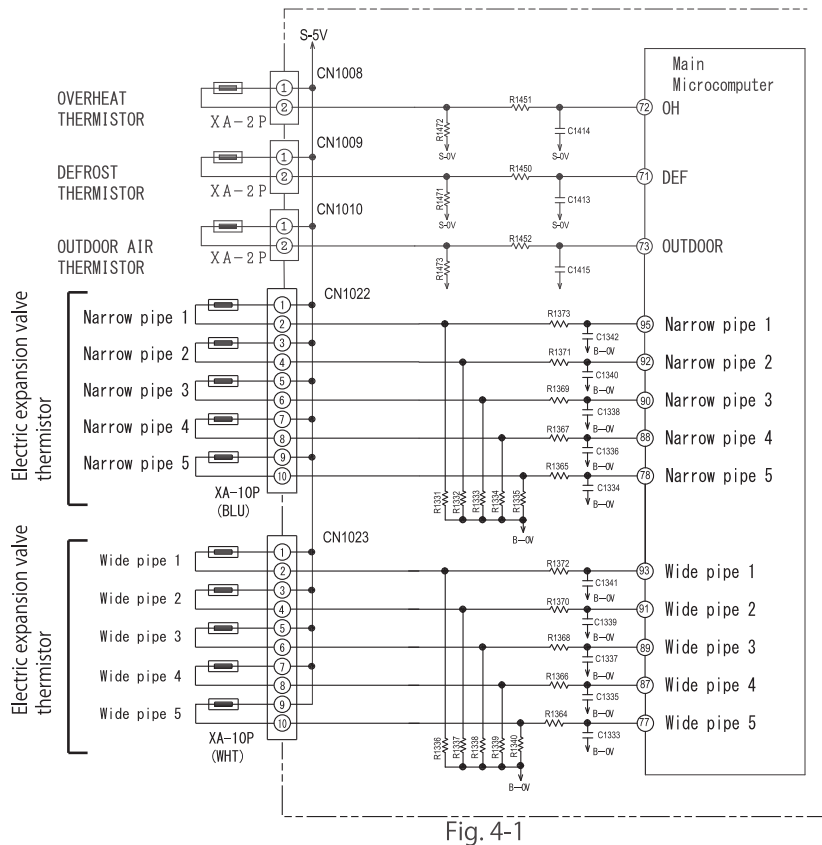

Fig. 4-1

- The OH thermistor circuit detects compressor head surface temperature, the DEF thermistor circuit detects defrost operating temperature, and the outside air temperature thermistor circuit detects the outside air temperature. In addition, the electric expansion valve thermistor (narrow pipe 1) detects the temperature of narrow pipe going to indoor unit 1 and (wide pipe 1) detects the temperature of the wide pipe going to indoor unit 1. (Narrow pipe 2) and (wide pipe 2) are for indoor unit 2.
- Thermistors are negative resistance elements. The resistance value grows smaller as the temperature rises, and grows larger as the temperature falls.
- If the compressor overheats, the resistance value of the OH thermistor grows smaller. S-5V is divided between the OH thermistor and R1472, and therefore the voltage of pin ⑫ on the main microcomputer rises.
- The voltage of pin ⑫ on the main microcomputer is compared with the value set and stored internally. If the set value is exceeded it is determined that the compressor has overheated, and operation is stopped.
- If frost accumulates on the outdoor heat exchanger, the temperature of the heat exchanger will fall rapidly. Therefore, the resistance value for DEF thermistor grows large and the voltage of pin ⑪ on the microcomputer will fall. If this voltage drops below the value set and stored internally, defrosting of the main microcomputer will start.
- Outdoor temperature is read by the outdoor temperature thermistor (voltage of pin ⑬ on the microcomputer). Commands from the indoor microcomputer, values read from the outdoor temperature thermistor, and values read from the OH thermistor are taken into account to control the speed of the compressor and the speed of the outdoor fan. Typical values that indicate the relationship between outdoor temperature and voltage are shown below.

Table 4-1

Outdoor temperature (°C)	-10	0	10	20	30	40
Voltage (V) at both ends of R1473	1.19	1.69	2.23	2.75	3.22	3.62

- The temperatures at narrow pipe 1 - 5 and wide pipe 1 - 5 are read by thermistors, and the amount that electric expansion valves 1 - 5 are opened is changed to control the distribution of refrigerant.

Reference:

When a thermistor is open and disconnected, pins ⑪ - ⑬, ⑨① - ⑨③ and ⑨⑤ on the main microcomputer are approximately 0V. When there is a short-circuit in a thermistor, these pins are approximately 5V, LD1351 will lit and LD1352 blinks during standby mode or running. Except for overheat thermistor, if there is a short-circuit in a overheat thermistor the LED indication during standby mode and running will be different as below Table 4-2.

The number of blinks by LD1352 indicates the area/portion in unit that thermistor detect have problem.

Table 4-2

Unit condition	LD1351 indication	LD1352 indication
Standby Mode	Lit	1 time blinking
Running	6 times blinking	Off

5. Electric Expansion Valve Circuit

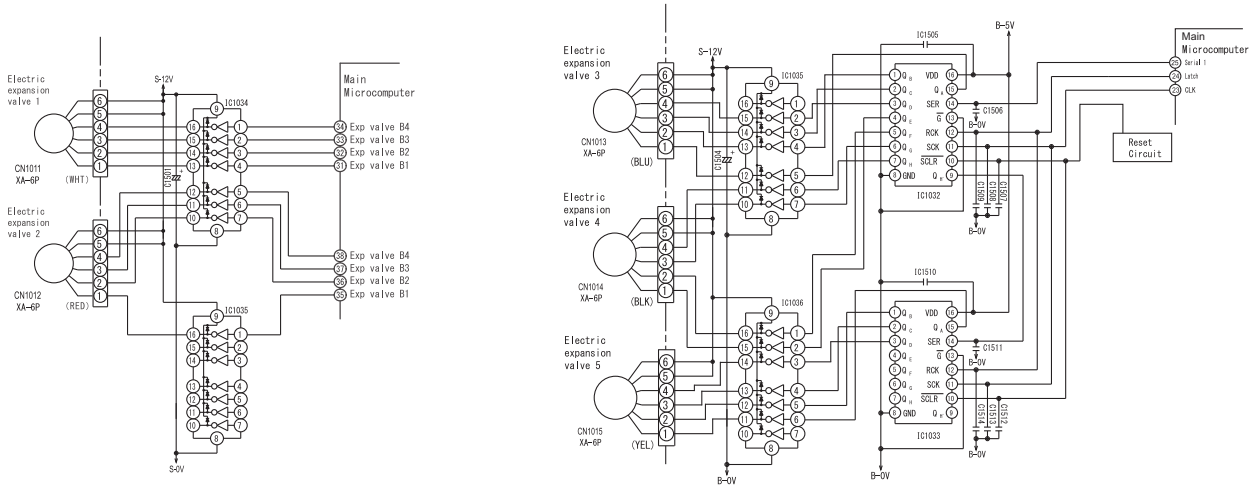

Fig. 5-1

- There are 5 electric expansion valves for indoor units 1-5.
- The electric expansion valves are powered by S-12V for expansion valves. 1- or 2-phase current is applied to 4-phase wound wires, switching the poles of the wound wires to control valve openings.
- The relationship between the switching direction of the current phase and the open/close direction of the valves is shown in the following table. When current is applied, approximately 0.9V passes through pins ①-④ of CN1011, CN1012, CN1013, CN1014 and CN1015; when no current is applied, it is approximately 12V. When the power is reset, the expansion valve is initialized for approximately 35 seconds. During initialization, use a tester to measure pins ①-④ on CN1011, CN1012, CN1013, CN1014 and CN1015. If there is a pin that does not change at approximately 0.9V or 12V, there is an abnormality in that expansion valve or the Main microcomputer.
- The logic waveform for when an expansion valve operates is shown in Fig. 5-2.

Table 5-1

CN1011, CN1012, CN1013, CN1014, CN1015, Pin No.	Lead wire	Power conditions							
		1	2	3	4	5	6	7	8
④	White	ON	ON	OFF	OFF	OFF	OFF	OFF	ON
③	Yellow	OFF	ON	ON	ON	OFF	OFF	OFF	OFF
②	Orange	OFF	OFF	OFF	ON	ON	ON	OFF	OFF
①	Blue	OFF	OFF	OFF	OFF	OFF	ON	ON	ON

Operation mode
 1→2→3→4→5→6→7→8 VALVE CLOSE
 8→7→6→5→4→3→2→1 VALVE OPEN

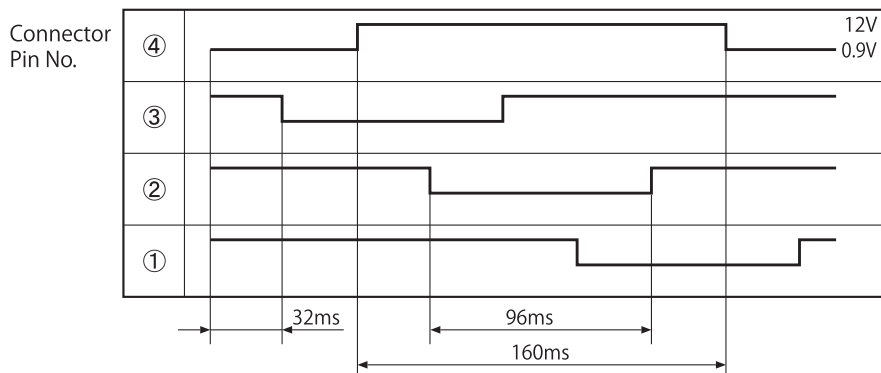

Fig. 5-2

When controlling an expansion valve, the temperature of the compressor head is detected and then the opening is adjusted to stabilize the valve to the target temperature. This control cycle is performed once every 20 seconds, and a few pulses are output.

6. Outdoor Fan Motor Control Circuit

- This outdoor unit is equipped with a built-in outdoor fan motor control circuit.

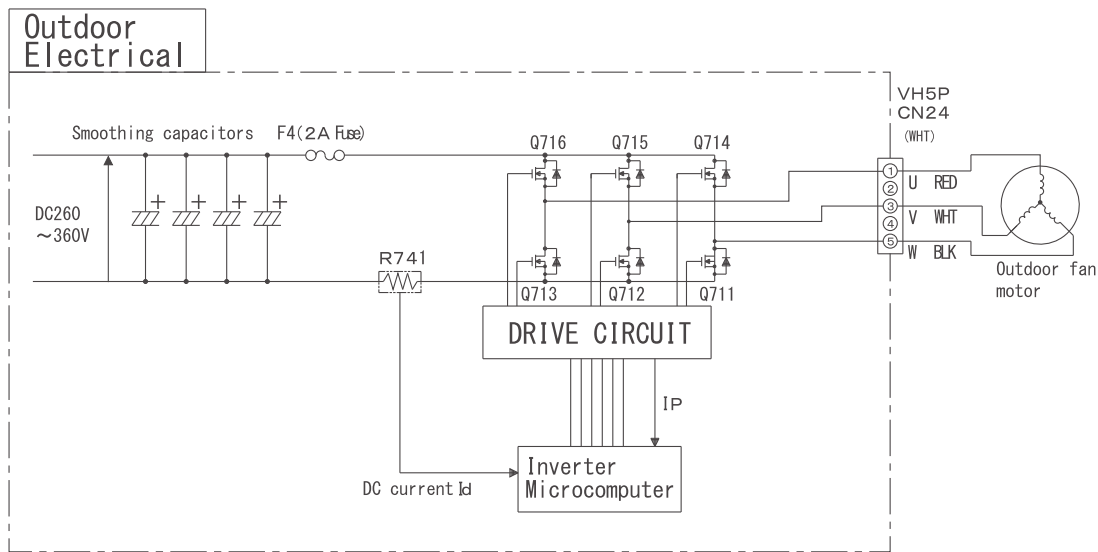

Fig. 6-1

Based on operation commands from the indoor microcomputer, the speed of the outdoor fan motor on this unit is determined by the main microcomputer and controlled by the inverter microcomputer.

Actual speed is estimated based on DC waveforms from R741 to control the speed so that it matches the operational commands.

Overcurrent and other failures in the outdoor fan motor are detected by the magnitude of the direct current.

(1) Control of outdoor fan motor at startup

If the propeller fan is already rotating at the start of operation, due to disturbances such as strong wind, operational behavior will vary according to the direction and speed of such rotation as described below. Favorable wind is defined as wind that blows outward from the mouth ring.

- | | |
|-----------------------|---|
| Strong headwind | : Control is not performed, to protect the equipment, and the propeller is blown in the opposite direction by the wind. The unit starts automatically once the wind has weakened. |
| Headwind | : After the speed reduces gradually and finally stops, the speed is controlled in the normal direction. |
| Favorable wind | : The speed of the fan is controlled normally. |
| Strong favorable wind | : Control is not performed, to protect the equipment, and the propeller is blown in the normal direction by the wind. The unit starts automatically once the wind has weakened. |

(2) Control of outdoor fan motor during operation

The speed of the propeller fan might drop during operation of the outdoor fan motor due to disturbances such as strong wind.

If such conditions continue for a long period of time, the propeller fan will stop. (Self-diagnosis lamp LD1351: Blinks 11 times)

When the fan is restarted, the operation described in (1) above is used.

(3) Confirmation method when self-diagnosis lamp LD1351 blinks 12 times

If LD1351 on the Main P.W.B. blinks 12 times (fan lock detected) and operation stops, use the following procedure to check the unit.

1. Mechanical locking caused by the insertion of foreign objects such as sticks into the propeller fan or freezing due to the accumulation of snow will cause fan lock to be detected and causing the unit stop its operation.
Remove any foreign objects.
2. Check whether CN24 is securely inserted. A poor connection will cause a fan lock detection and causing the unit stop its operation. If CN24 is loose, insert it securely.
3. Strong wind around the outdoor unit might cause a fan lock detection.
Check if the unit restarts. (Several minutes might be required for the unit to restart.)
If the unit continues to operate after restarting, there is no failure in the outdoor fan motor or electrical components.
4. Perform a check of the outdoor fan motor. The procedure is shown below.

Procedure for Checking the Outdoor Fan Motor

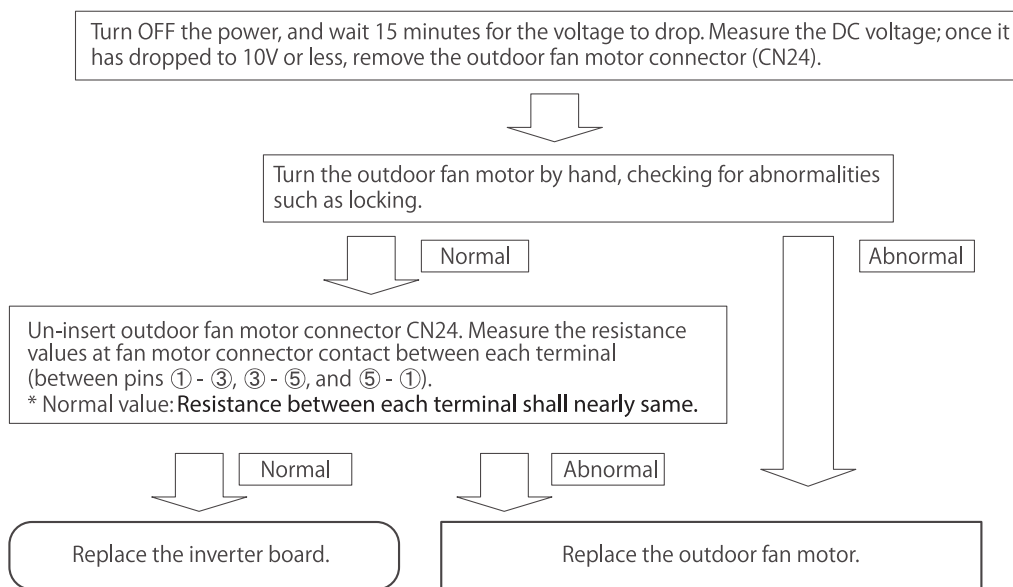

5. Insert the outdoor fan motor connector (CN24).

* Also use the above procedure if F4 (2A fuse) is blown.

Caution

* The power supply for the outdoor fan motor is also used as the power supply for the compressor, and therefore has a high voltage (DC260 to 360V). Use sufficient caution to avoid electric shock when checking operations and performing repairs.

7. Circuits for Communication between Microcomputers

- This unit uses two microcomputers: a main microcomputer and an inverter microcomputer. The two-way communication circuit shown in Fig. 7-1 is used for communication between these two microcomputers.

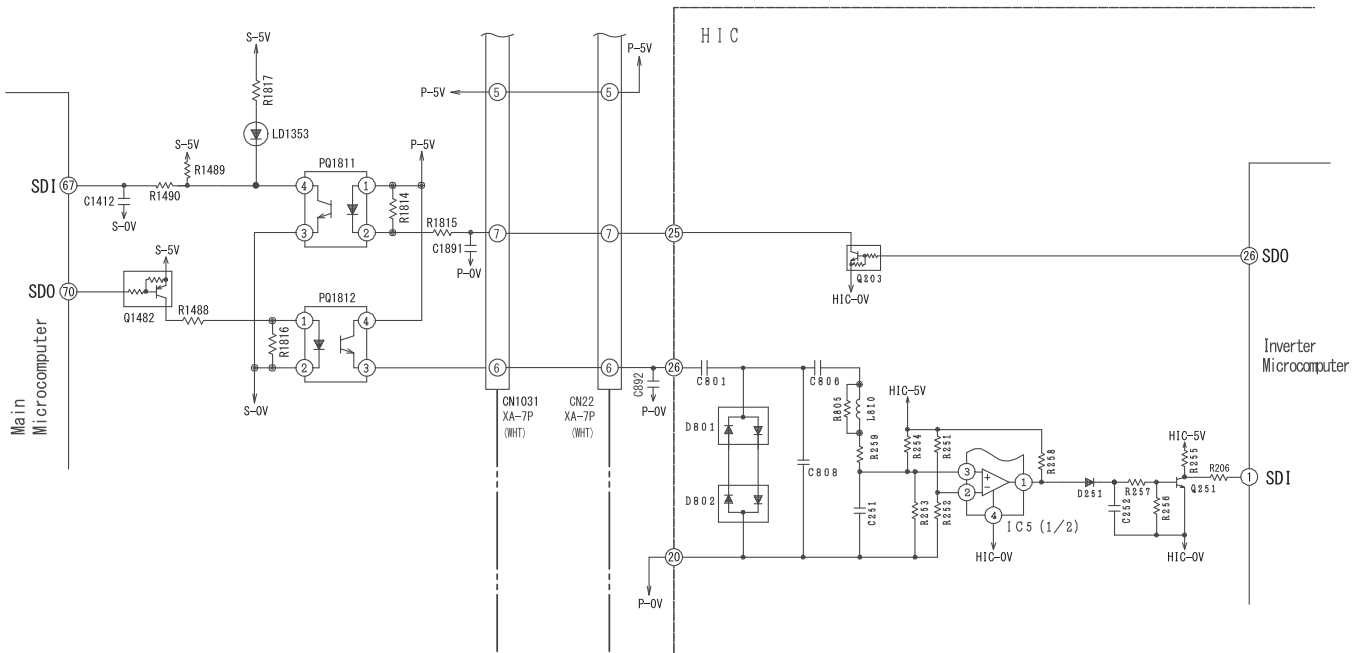

Fig. 7-1

- Signals from the main microcomputer to the inverter microcomputer follow this route: main microcomputer ⑦⑩ → Q1482 → PQ1812 → IC5 → Q251 → inverter microcomputer ①.
- Signals from the inverter microcomputer to the main microcomputer follow this route: inverter microcomputer ②⑥ → Q203 → PQ1811 → main microcomputer ⑥⑦.

8. Indoor/outdoor communication circuit

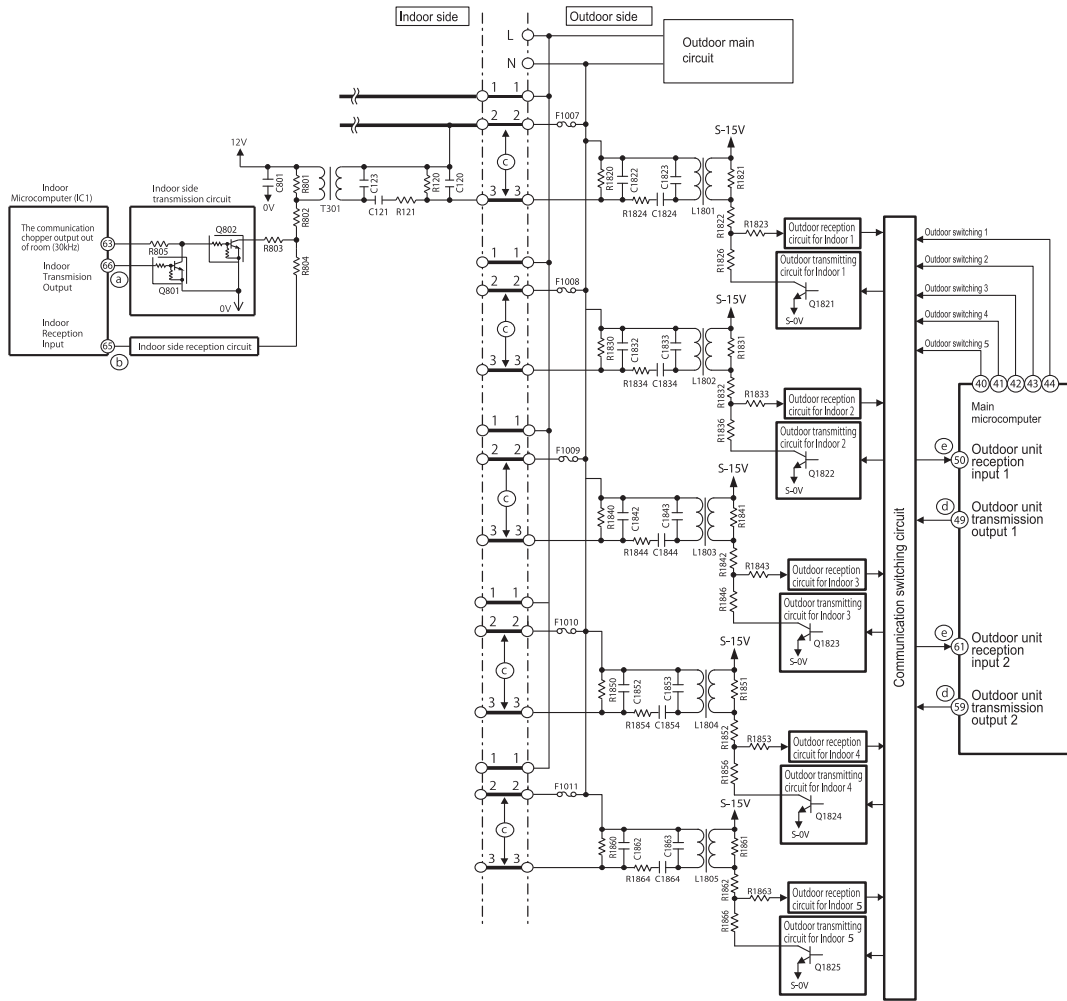

Fig. 7-2

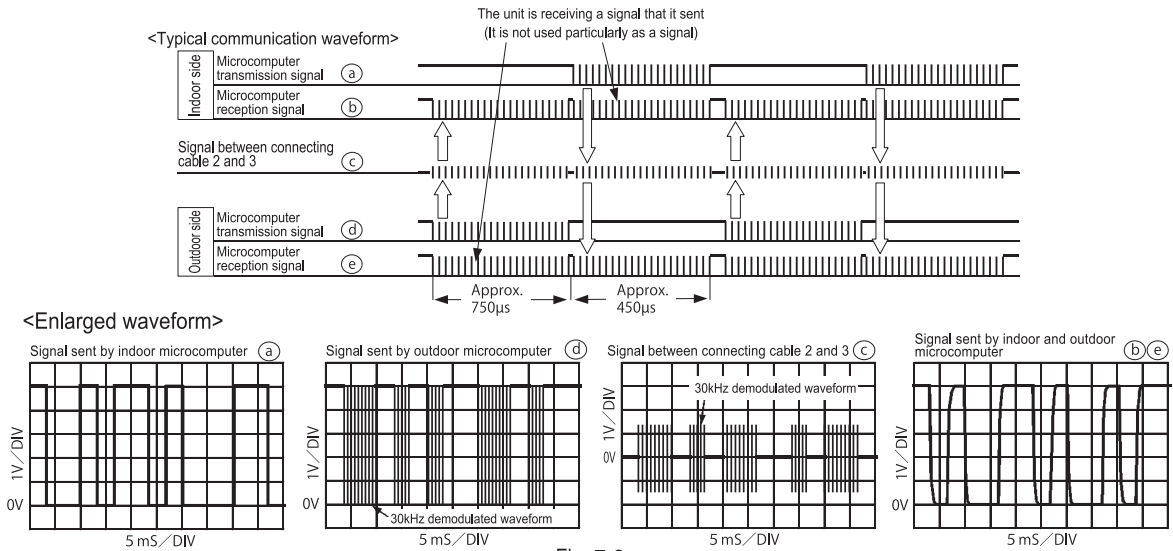

Fig. 7-3

- * Indoor and outdoor communications are conducted by using lines 2 and 3 of connecting cable. Line 2 of connecting cable is share with a transmission channel that powers the indoor unit.
- * Data communicated between the indoor and outdoor units are outputted from the microcomputer as serial signals and are transmitted as demodulated by a 31kHz carrier wave (for indoor) and a 30kHz carrier wave (for outdoor).

Check

If the communication fails between the indoor and outdoor units for some reason, the product will give a self-diagnosis display either by “the timer lamp blinking 3 times (indoor failure)” or “the the timer lamp blinking 12 times (outdoor failure)” depending on the cause.

8. Hibernation Mode

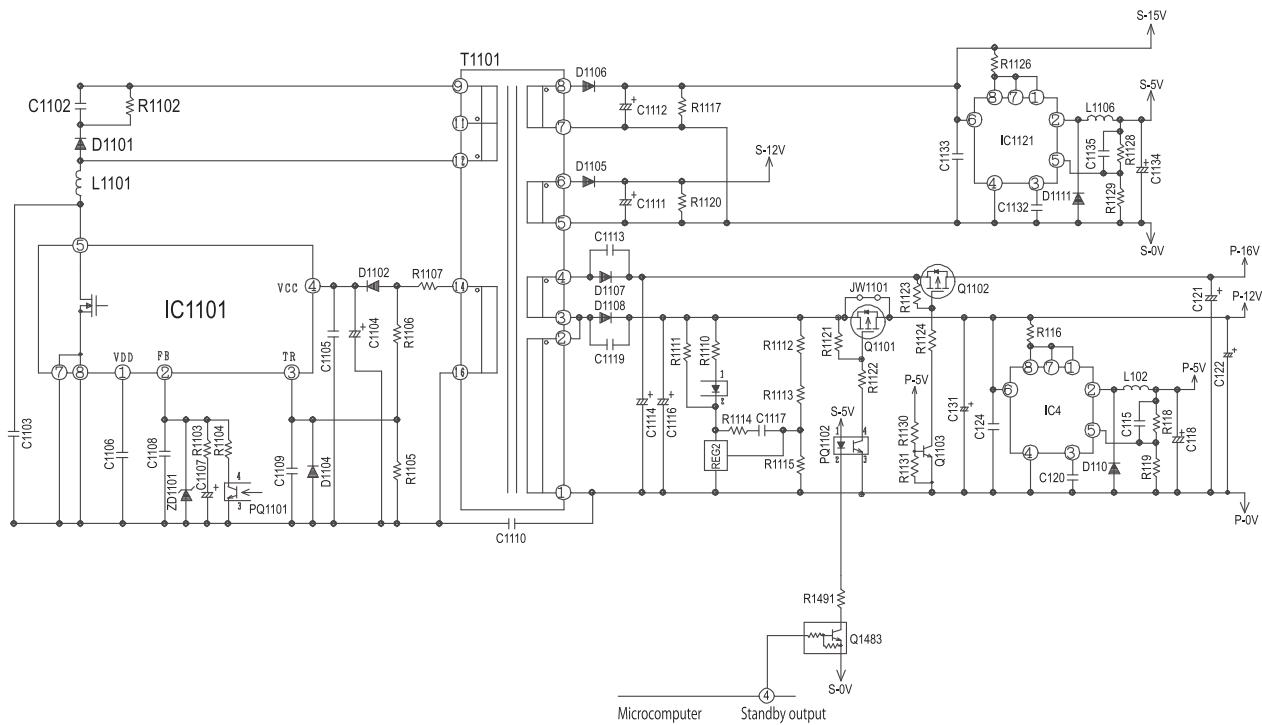

Fig. 8-1

- This model have designed to enter hibernation mode for energy saving and power consumption reduction during stanby.
 - Unit will enter hibernation mode during below stanby condition if not received any signal from remote controller and expansion valve already completed initialization .
 - 1) Stanby continuesly
 - 2) Unit in running condition, then off the unit by remote controller and leave the unit in stanby condition.
 - During hibernation activation, main microcomputer pin ④ will change to LOW condition.
Due to this pin become LOW Q1483, PQ1102 and Q1101 will be OFF. As Q1101 OFF, P-12V and P-5V will drop to 0V. Due to P-5V drop to 0V, Q1103 will be OFF and causing P-16V also drop to 0V.
 - During hibernation mode, DC voltage will be as below condition.
 - (1) S-15V : Maintain at 15V
 - (2) S-12V : Maintain at 12V
 - (3) S-5V : Maintain at 5V
 - (4) P-16V : Drop to 0V
 - (5) P-12V : Drop to 0V
 - (6) P-5V : Drop to 0V
- All LED on the Main P.W.B and Inverter P.W.B (LD301, LD1351, LD1352, LD1353, LD1401, LD1402, LD1403, LD1404) will be OFF during this mode.
- If outdoor unit have failure/error, all indication including error diagnosis LED will be OFF once the smoothing capacitor (C021 ~ C024) voltage reduce to 29V.
 - For inspection during hibernation mode, service person can measure DC voltage S-15V, S-12V and S-5V on Main P.W.B.
But to measure DC voltage P-16V, P-12V and P-5V on Inverter P.W.B., service person shall on the indoor unit by remote controller first. This will change the unit from hibernation mode to normal.

9. H-LINK (Optional part)

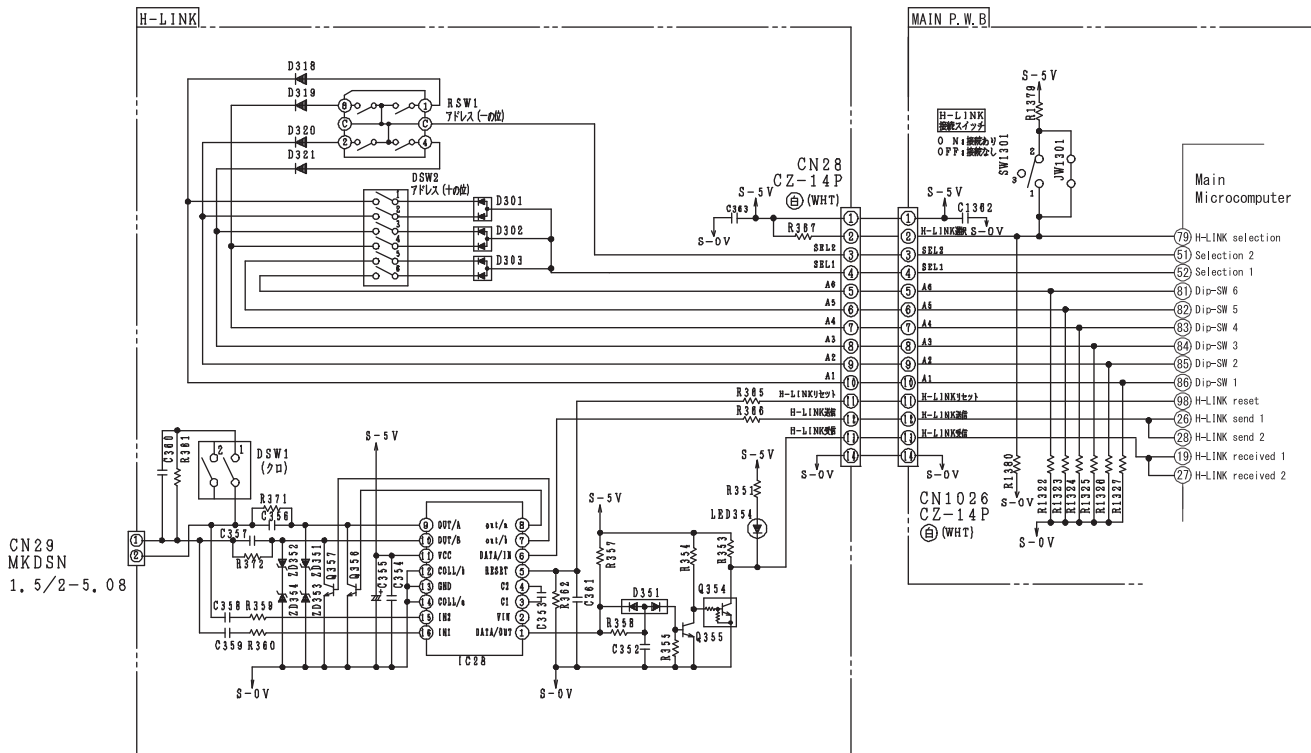

Fig. 9-1

- This model have designed to be connected to Central Control Station through H-LINK board.
- This H-LINK board are sell as optional part and it part number is SPX-RAMHLK.
- H-LINK board CN28 shall be connected to MAIN board CN1026 through 11 pin cord assembly.
- RSW1 and DSW2 shall be set according to the refrigerant cycle number that determine by service personal.
- Central Control station shall be connected to H-LINK board through CN29.
- DSW1 pin 1 shall be switch on only one position in whole H-LINK system.
- SW1301 must be switch on to activate the H-LINK .
- Hibernation mode will be automatically disable if the unit activate the H-LINK system.
- Detail of installation of the H-LINK board shall refer to next page {H-LINK Board (SPX-RAMHLK) Installation Manual}.

9.1 H-LINK Board (SPX-RAMHLK) Installation Manual

9.1.1 Check through H-LINK board accessories.

No	Part Name	Quantity
①	H-LINK board	1
②	Board support	3
③	14 pin cord	1
④	Installation manual	1

9.1.2 H-LINK board installation

- i. Assemble board support (3 pcs) to H-LINK board holes as following picture.

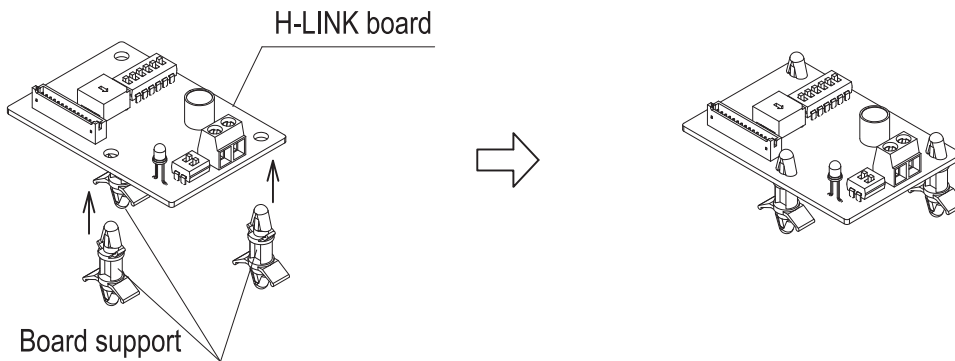

- ii. Insert the H-LINK board into the MAIN board (please use 3 holes on MAIN board that designed to fit the H-LINK board).

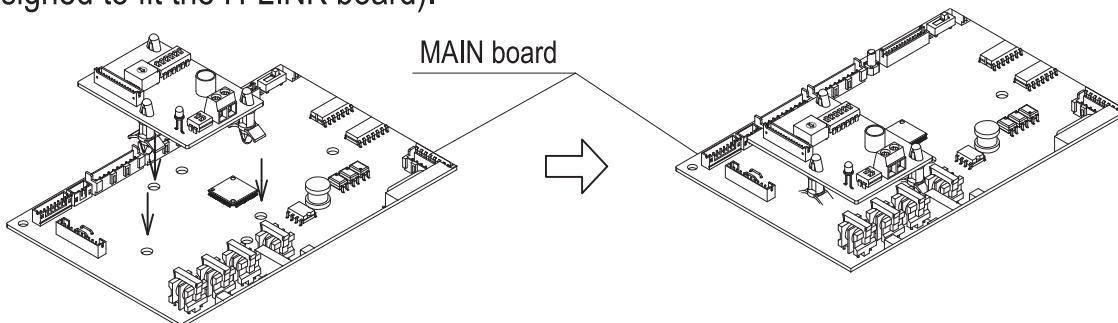

- iii. Insert the 14 pin cord to the CN28 of the H-LINK board and CN1026 of the MAIN board.

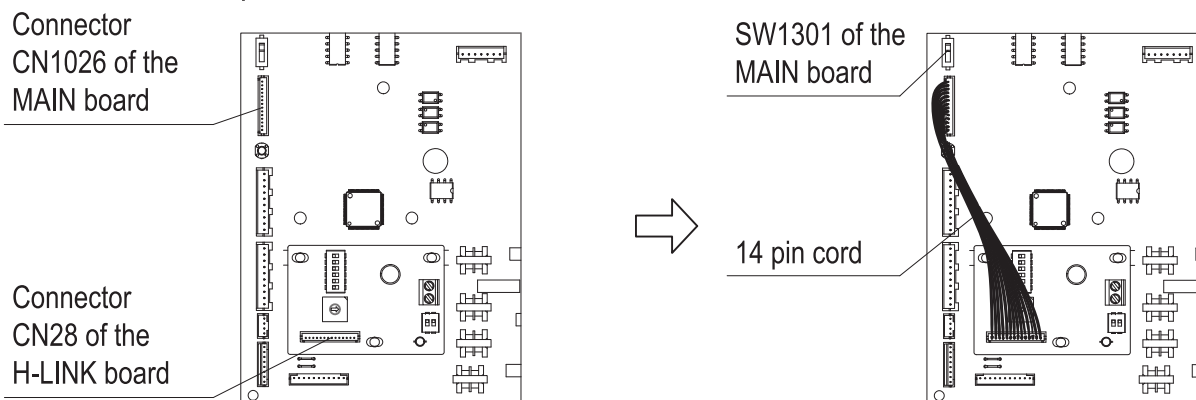

- iv. Set the SW1301 of the MAIN board to ON condition before start the H-LINK operation (default position from factory is OFF condition).

9.1.3 DIP switch setting.

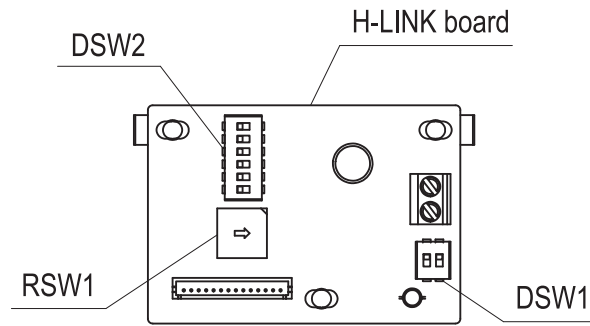

i. DSW1 setting (terminal resistance setting).

Terminal resistance setting set by pin number 1 of DSW1.
(Default setting from factory is pin number 1 of DSW1 set to OFF condition).

Terminal resistance should be ON in only one position in whole H-LINK.
After checking terminal resistance setting of whole H-LINK, pin number 1 of DSW1 should be set properly.

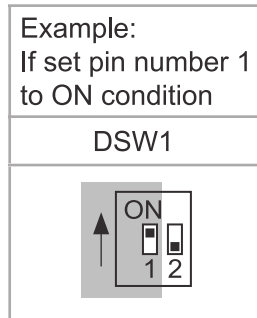

ii. DSW2 and RSW1 setting.

Refrigerant cycle number is set by DSW2 and RSW1.

DSW2 (tens digit)	RSW1 (ones digit)	Example: Setting cycle number to 15	
		DSW2	RSW1
Default setting from factory for DSW2 and RSW1 are set to OFF and 0 respectively.		Pin number 1 is ON	The set position is 5

9.1.4 Connect the H-LINK board to the Central Station by fixing the transmission cable at CN29.

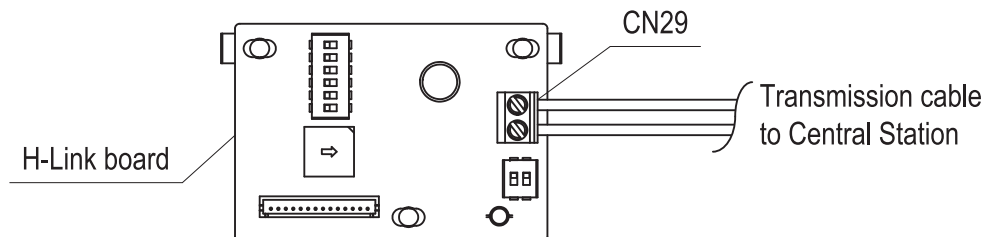

The transmission cable used shall be as below.

- i. 2 cores cable (0.75mm² to 1.25mm²). Model : VCTF, VCT, CVV, MVVS, CVVS VVR, VVF.
- ii. 2 cores twist pair cable. Model : KPEV, KPEV-S.

Total length of the transmission cable shall be below than 1000m.

9.2 Error code during H-LINK operation.

- If there is any abnormality to the unit, error code will be displayed at Central Control Station.
- Error code displayed, its self-diagnosis and its suspected cause of the error shall refer to the table below.

Error Code	Self-Diagnosis Name	Suspected area	Main Cause
7 1	Four way valve malfunction	Indoor	Four way valve malfunction
7 3	Indoor communication circuit fault	Indoor	Indoor communication circuit fault
7 5	Power relay contact welding	Indoor	Power relay contact welding
7 6	Abnormal water level	Indoor	Abnormal water level
7 9	Thermistor problem	Indoor	Thermistor problem
7 A	Indoor fan problem	Indoor	Indoor fan problem
7 C	Outdoor communication circuit fault	Indoor	Outdoor communication circuit fault
7 D	EEPROM reading error	Indoor	EEPROM reading error
8 2	Ip cut stop	Outdoor	Ip cut input signal detection
8 3	Abnormal low speed	Outdoor	Detect out of step condition
8 4	Switching failure	Outdoor	Detect out of step condition
8 5	Overload stop	Outdoor	At the lowest speed with overload
8 6	OH stop	Outdoor	OH has reached stopping temperature
8 7	Thermistor fault	Outdoor	Thermistor disconnection / short circuit
8 8	Communication error between INV	Outdoor	Communication error between microcomputer
8 9	Misconnection	Outdoor	Connect a single model
8 A	Power supply voltage error	Outdoor	DC voltage is out of the limit value range
8 B	Fan error detection 1	Outdoor	Fan OVL stop
8 C	Fan error detection 2	Outdoor	Fan Ip cut, out of step etc.
8 D	EEPROM Error	Outdoor	Read error (ACK, checksum)
8 E	Overvoltage error	Outdoor	DC voltage is out of the limit value range
8 F	Circuit abnormality	Outdoor	ACT circuit, Is / Vs abnormality etc.
61	Connection Problem	Indoor	Outdoor communication circuit fault
		Indoor	EEPROM reading error
		Outdoor	Connect a single model
		Outdoor	Communication failure between outdoor and Central Station
		Indoor/Outdoor	Indoor or outdoor communication circuit fault
			Connecting cable 2 or 3 between indoor and outdoor disconnect

SERVICE CALL Q&A

Cooling operation

Q1 The compressor sometimes stops during cooling.



A1 Check if the heat exchanger of the indoor unit is covered with frost. Wait for 3 to 4 minutes until the frost disappears.

Cooling when the room temperature is low may cause the heat exchanger of the indoor unit to gather frost.

Dehumidification

Q1 The indoor unit produces a noise that goes "shaaahh" during dehumidification.



A1 That is a noise produced by refrigerant flowing through the pipe.

Q2 Cold air comes out during a dehumidifying operation.



A2 To improve the dehumidification efficiency performs quiet fan operation. Therefore the air is cold and it is not a malfunction.

Q3 The operation does not stop even by setting the temperature higher than room temperature on the remote controller.



A3 It sets to perform dehumidifying operation by setting the temperature slightly lower than remote controller setting.

Heating operation

Q1 The product sometimes fails to produce a wind during heating.



A1 Defrosting is in progress. Wait 5 to 10 minutes until the frost on the outdoor unit disappears.

Q2 The product begins with a slight fan speed during heating even though set to "Hi fan" or "Med fan" or "Low fan" or "silent fan".



A2 At the first of the heating, the product will run for 30 seconds with a slight fan speed. When set to strong fan speed, the product will begin with a slight fan speed operation, producing a weak fan speed for 30 seconds, and then switch to strong fan speed.

Q3 The product stops during heating even though it is set to "30°C."



A3 When heating is conducted despite the high outdoor temperature, the product may stop to protect its equipment.

Auto-fresh defrost

Q1 During heating, I turned off the product by using the START/STOP button. But the "operation lamp" is blinking and the outdoor unit is running.



A1 The "auto-fresh defrost" should be working. When stopped, the product will check its outdoor unit for frost and, if there is any frost, conduct defrosting and then stop operating.

Common, etc.

Q1 In "automatic fan speed" mode, the indoor fan changes from strong fan speed to weak fan speed to slight fan speed.



A1 This does not abnormal. It is because the cold fan speed prevention is working.

In fan speed "automatic" mode, the product will sense the heat exchange temperature and, when the temperature goes down, the product will automatically switch to strong wind to weak fan speed to slight fan speed.

Q2 At operation startup, the outdoor unit becomes noisy.



A2 At operation startup, the product will set the rotation speed of the compressor to full power and increase its heating and cooling capacity, resulting in a slightly higher noise level. This is not a sign of a breakdown.

Q3 The outdoor unit sometimes changes in its noise.



A3 The difference between the thermometer temperature setting and room temperature will change the rotation speed of the compressor. This is not a sign of a breakdown.

Q4 There is a difference between the temperature setting and room temperature in room temperature control.



A4 The room structure, air stream, or other factor may cause a gap between the room temperature setting and actual room temperature. If there is any difference between the setting and the room temperature, adjust the temperature setting to match the living space to a comfortable temperature.

Q5 The product will not produce wind right after startup.



A5 After turning ON the power switch or breaker, setting the product to heating or dehumidification will activate a preliminary operation for 1 minute. At that time, heating will cause the operation lamp to blink. This is not a sign of a breakdown.

Q6 I performed internal cleaning, but didn't succeed in controlling the mold in the room.



A6 Internal cleaning will clean the inside of the indoor unit of the air-conditioner, thereby controlling mold generation. This will not control the mold in the room.

Wireless remote control

Q1 The timer will not become set.



A1 Have you set the product to the current time? The timer cannot be set unless it is set to the current time.

Q2 The current time display will disappear at once.



A2 The current time disappears 10 seconds later. The timer set display is given priority.

When set to the current time setting, the reading blinks for about 3 minutes.

Q3 I made a timer "reservation". But the time setting has disappeared.



A3 Is the time not past the reserved time? The set time disappears when the current time reaches the reserved time.

Q4 I tried to set the "sleep" timer while the ON timer is reserved. But it will not set itself to a desired time.



A4 The time set in the "sleep" timer can be set with a time up to the time set with the ON timer. If the end time of the "sleep" timer is past the time set with the ON timer, you cannot make that setting.

Q5 I set the "sleep" timer during operation. But
 ① the indoor fan will not run (it will not produce wind)
 ② wind intensity will not change.



A5 ① This occurs when the room temperature and humidity have reached their settings during dehumidification and the air-conditioner is in a pause. The product will begin again to run within about 3 minutes.
 ② The product will run with the wind speed set to a "quiet" state.

Q6 I tried to change the setting with the "room temperature" button of the remote control unit in vain.



A6 You cannot make this setting when the product is in "air purification" mode. Moreover, you cannot set the product to a desired setting when quick laundry or dew control is being performed with the "auto" or "quick dehumidification" button.

Q7 The temperature setting field on the remote control unit displays $+f^{\circ}\text{C}$ or $-f^{\circ}\text{C}$.



A7 The product will give a display when you operate the product in "auto" using the operation switch button. This can be controlled within the range of $\pm 3^{\circ}\text{C}$.
 The product will display $+f^{\circ}\text{C}$ if the temperature is $f^{\circ}\text{C}$ higher than the room temperature in automatic setting.
 The product will display $-f^{\circ}\text{C}$ if the temperature is $f^{\circ}\text{C}$ lower than the room temperature in automatic setting.

Q8 The remote control unit will give no display in response to a push of the "vertical vane" button.



A8 The remote control unit displays nothing.

Procedure for Disassemble and Reassemble

MODEL : RAS-EH36PHLAE

1. Front Panel

- (1) Pull the panel by holding it both lower sides with both hands.



Fig. 1

- (2) When the panel opens full, pull the inner part of the right arm inward and pull the panel forward while closing it gradually.

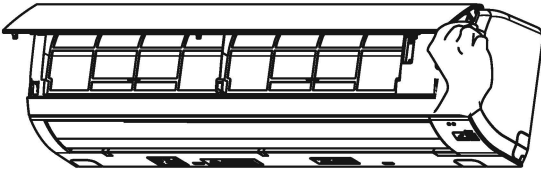

Fig. 2

2. Front Cover

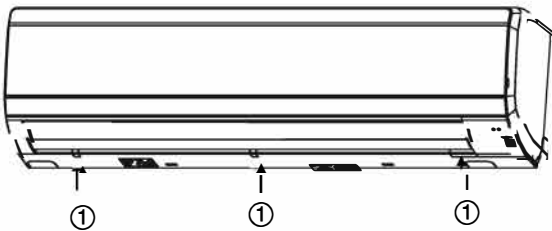

Fig. 3

- (1) Remove the caps and uncrew at lower portion of the front cover.

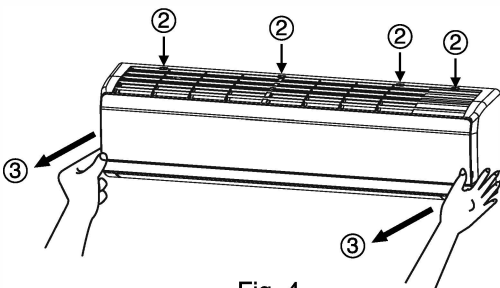

Fig. 4

- (2) Firmly press 4 hooks at top of front cover by tools until the hook release from slot.
- (3) Pull the front cover to front side.

3. Main P.W.B and Reception/Indication P.W.B

- (1) Remove each connector from the lead wire.
- (2) Remove the two P.W.B supports from the main P.W.B.
- (3) After removing the reception/indication P.W.B cover, pull the support hook at the right side of the reception/indication P.W.B and pull out the P.W.B forward.

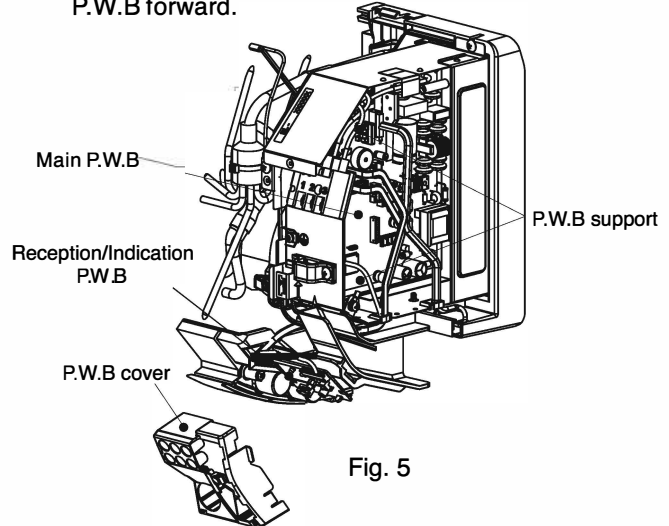

Fig. 5

4. Tangential air flow fan

- (1) Press to unhook (2 places) between drain pan and cabinet and pull the claw forward to remove the drain pan.

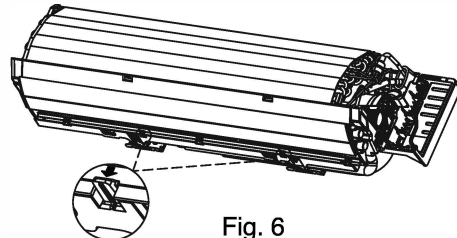

Fig. 6

- (2) Unscrew 2 portions at evaporator support and tangential fan.

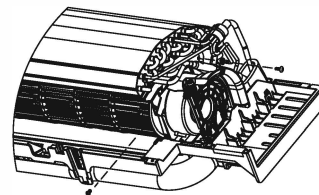

Fig. 7

- (3) Remove the locking hook of the bearing cover from the cabinet. Gently pull up the evaporator with bearing cover by holding it at lower side and pull out tangential fan.

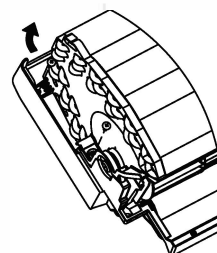

Fig. 8

- (4) Remove the two lock screws from the fan motor holder and one screw from the evaporator support plate.
- (5) Pull up the evaporator by holding it at the lower side. Insert a screwdriver through the space between the evaporator and fan motor holder and loosen the fan lock screws to remove the air flow fan and fan motor.

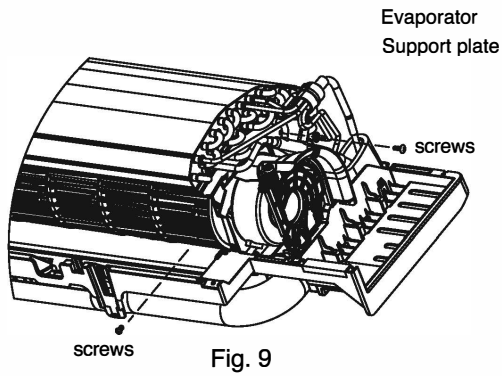
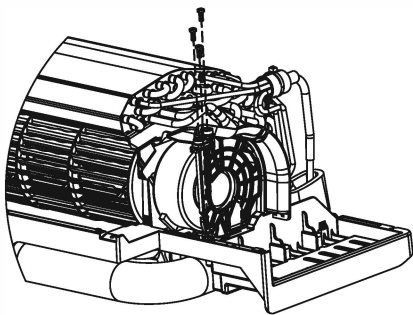

Fig. 9

(5) Fan motor

- (1) Unscrew (3 portions) between fan motor support and cabinet.



- (2) Release upper fan motor support by pressing hook to unlock and pull to the right.
- (3) Release lower fan support and remove the fan motor.

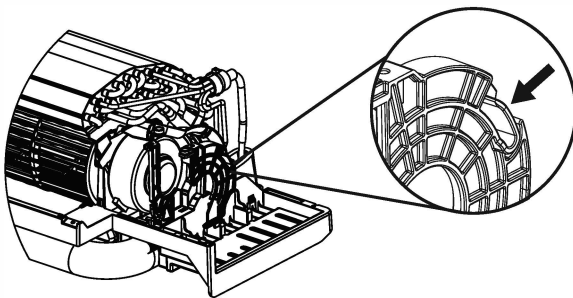
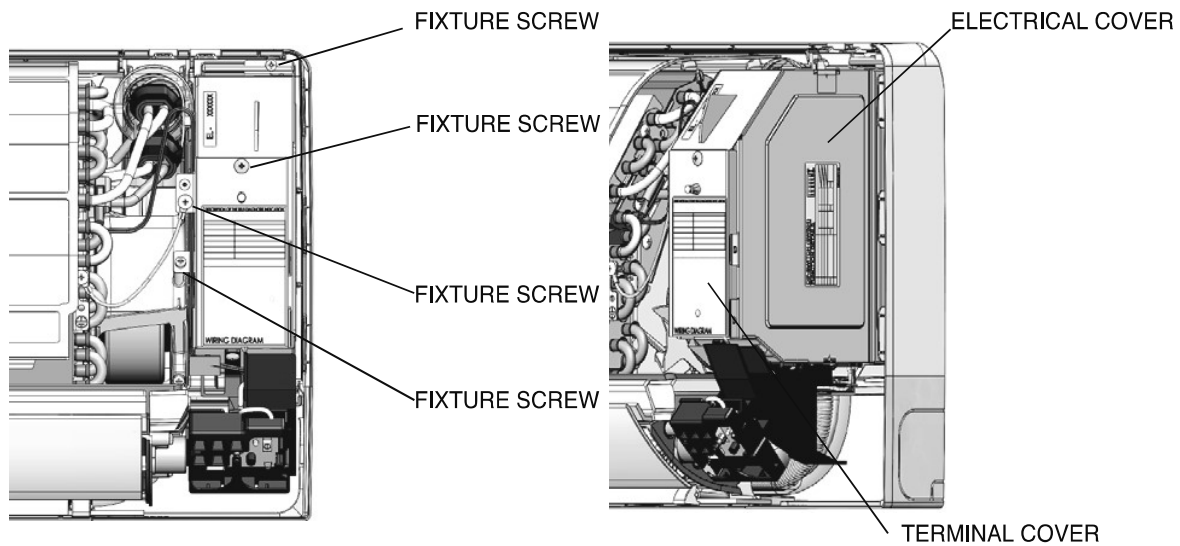

Fig. 10

STRUCTURE OF AN INDOOR UNIT ELECTRIC PARTS



Removing electrical parts

1. Remove the electrical parts cover.
2. Remove the connectors from the CN4 (heat exchange thermistor), CN9 (Vertical sweep motor) and CN2 (fan motor), CN12 (horizontal sweep motor).
3. Remove four lock screws.

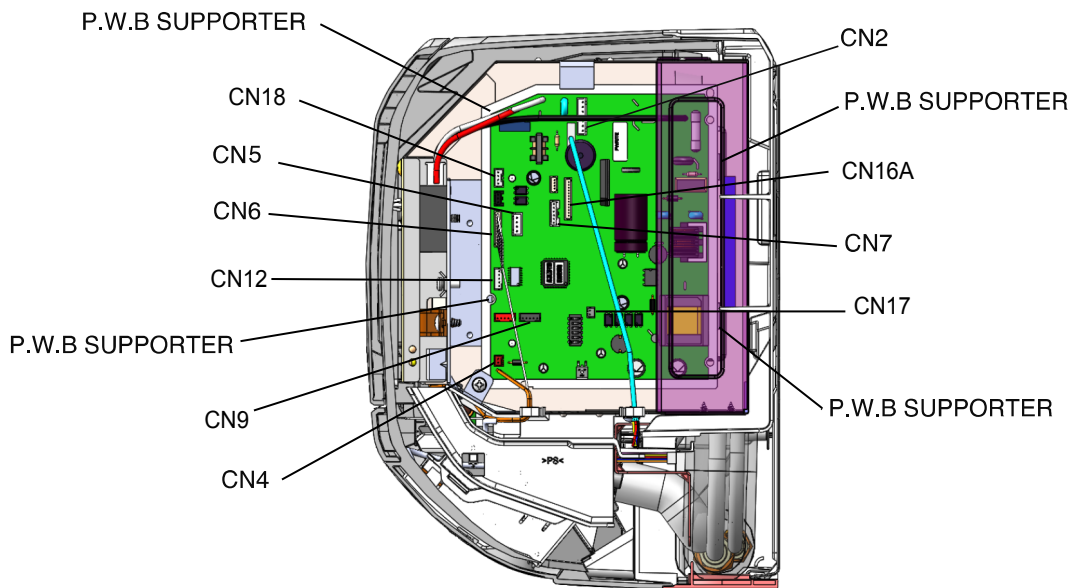

Removing control P.W.B.

1. Pull off all the wires from terminal 1,2,3 or remove the terminal [1,2,3] from the chassis.
2. Remove the P.W.B from the P.W.B support.

Remove the indicating P.W.B.

1. Remove the connector from the CN16A on the control P.W.B.
2. Remove the upper hook from the indicating P.W.B. lock resin, pull the P.W.B. forward a little and remove it.

Other instructions

(1) Detaching and reattaching the receptacles for tab terminal

All the receptacles for connecting tab terminals are with a locking mechanism. Forcibly pulling any such receptacle without unlocking it will destroy it. Be on guard.

When reconnecting it, insert it securely all the way home.

· Receptacle types and how to unlock them

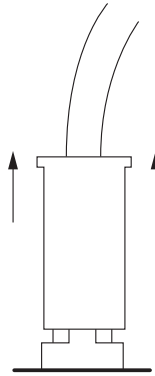

Vertical (with a resin case)

Hold the resin case and pull it out.

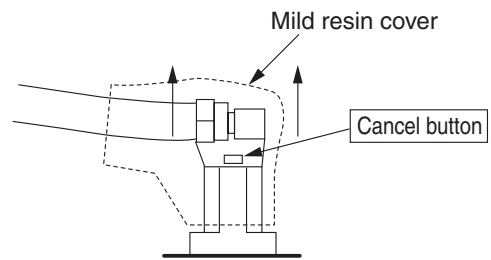

Horizontal (with a mild resin cover)

Hold the cancel button down on the mild resin cover while pulling it out.

(2) Detaching and reattaching the board connector

The product comes equipped with many board connectors provided with lock mechanism. Forcibly pulling any such part without unlocking it will destroy it. Be on guard. When reconnecting it, insert it securely all the way home.

Pinch the locking mechanism with your fingers and pull it out unlocked.

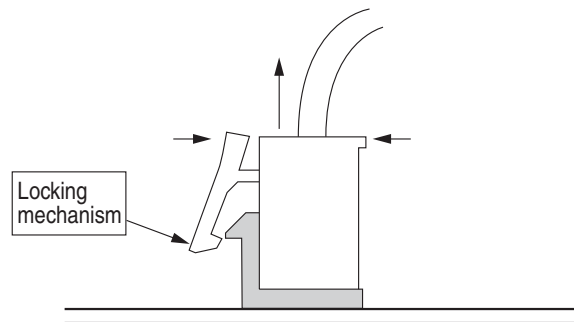

(3) Do not detach or reattach the connectors while energized

Do not under any circumstances detach or reattach the connectors while energized. That would destroy the board components and fan motor. For both the indoor and outdoor boards, ensure that the smoothing capacitor has discharged its electricity fully before you do your work.

No	Function	Description
1	Self-diagnosis display [Display on the indoor unit side]	<ul style="list-style-type: none"> · The failure mode detected on the indoor unit side is displayed by blinking the "timer lamp". And a failure detected on the outdoor unit side will be indicated by the "time lamp" blinking 4 times. · If the outdoor unit side detects a failure, the product will first conduct several operation retrials. <p>There are some failure modes with no lamp display while retrials are continued.</p> <p>[Failure mode where retrials are continued and the indoor unit lamp does not end up giving a display]</p> <ul style="list-style-type: none"> OH thermistor heat-up Overload lower limit cut Low-frequency things
	[Display on the outdoor unit side]	<ul style="list-style-type: none"> · The failure mode detected on the outdoor unit side is displayed by blinking the "LD301". Detecting a failure will stop the outdoor unit and keep blinking the LD301 until it is restarted. <p>(The communication error will persist until the communication is reestablished.)</p>
2	Self-diagnosis memory	<ul style="list-style-type: none"> · The failure modes detected on the indoor and outdoor unit sides are stored in the nonvolatile memory of the indoor unit and can be read later on. (The memory will remain even after power-off.) · The failure modes detected on the outdoor unit side are written in memory every time any such mode occurs. The failure mode can therefore be detected on the indoor unit side without waiting for the retry frequency to reach the display of the indoor unit lamp. Moreover, the normal self-diagnosis display function which rarely occurs will store and display failure modes that do not end up displaying the indoor unit lamp. (Any such mode may be unable to be stored if indoor or outdoor communications is in a failure.) · The product stores 5 last-stored failure modes. · There is a function for deleting memory. Once you clear the memory and run the product for several days, you can read the failure modes and check them, thereby detecting the less frequent failure phenomena. · Failure modes can be checked by both the blinking of the lamp of the indoor unit and the display of the remote control liquid crystal display.

※The "self-diagnosis function of the communication circuit" available in our conventional models is now incorporated as part of the normal self-diagnosis function. In the case of a failure in the communication circuit, you do not have to conduct a special operation and the operations can be automatically divided into 3 blinking operations and 12 blinking operations of the timer lamp. However, a strong external noise may have resulted in 12 times of blinking.

DISMANTLE AND ASSEMBLY PROCEDURE

■ MODEL RAC-EH36WHLAE

1. Electrical parts (preparation to remove board)

- (1) Remove screw that fix the service valve cover and push it down to take it out.
- (2) Remove the screws on both sides of top cover and then remove the top cover.

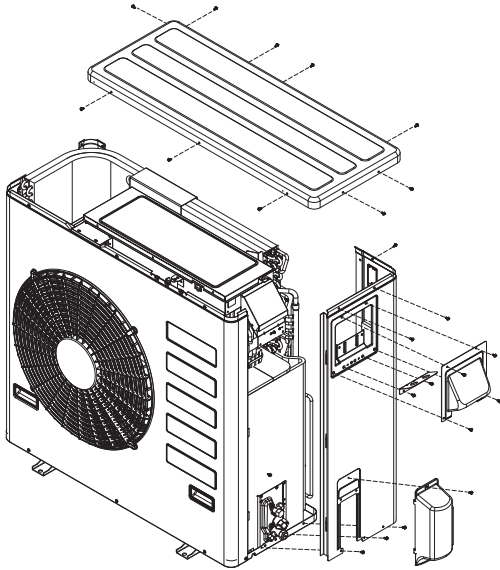

- (3) Remove the screws that holding the electrical cover and then remove the cover.

2. Dismantle procedure of main board

- (1) Un-insert connector (16 places), TAB terminal (9 places) and un-screw 1 piece earth screw.

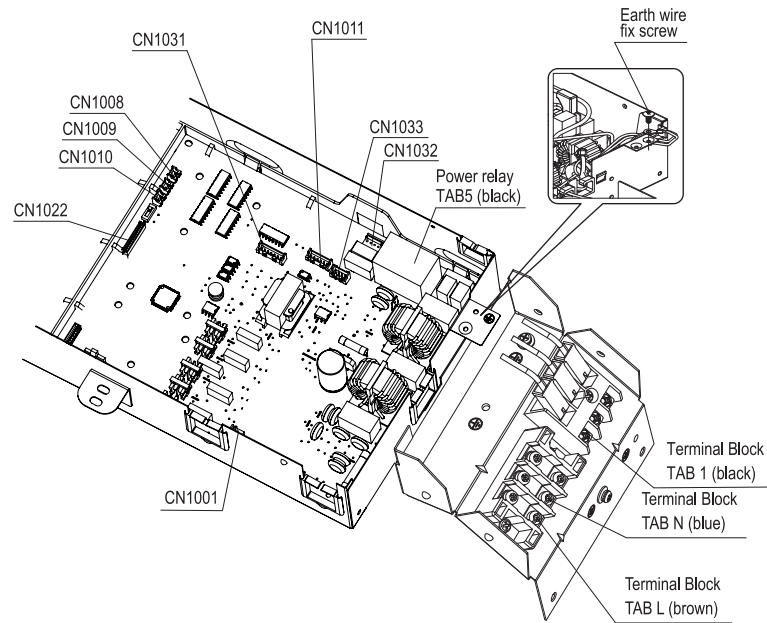

- (2) Release the hooks (2 places) that locking the board and lift up the board to take it out.

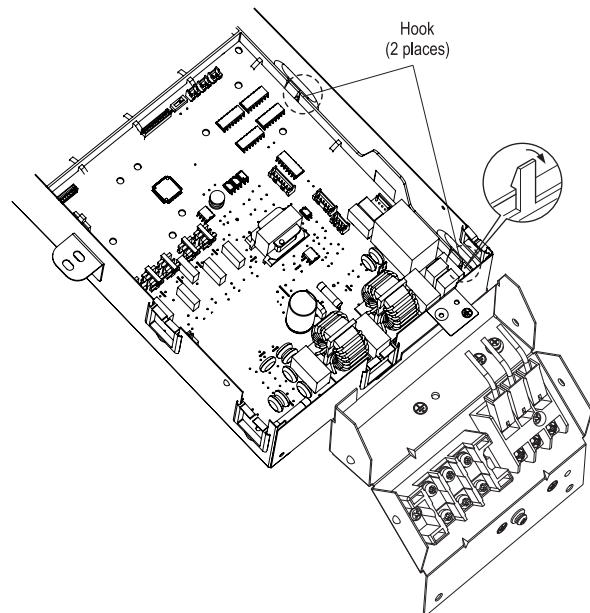

3. Assembly procedure of main board

- (1) Insert back the board into pcb support and lock it with hook (2 places).

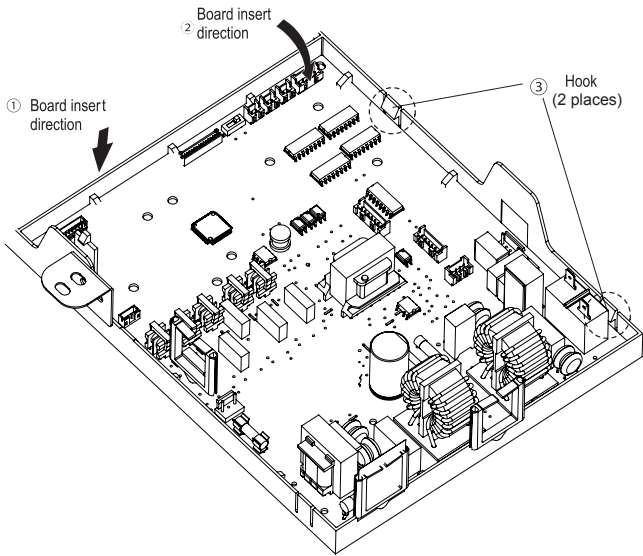

- (2) Insert back the connectors (16 places), TAB terminals (9 places) and 1 piece of earth screw.

4. Dismantle procedure of inverter board

- (1) Un-insert connectors (4 places) and TAB terminal (2 places).

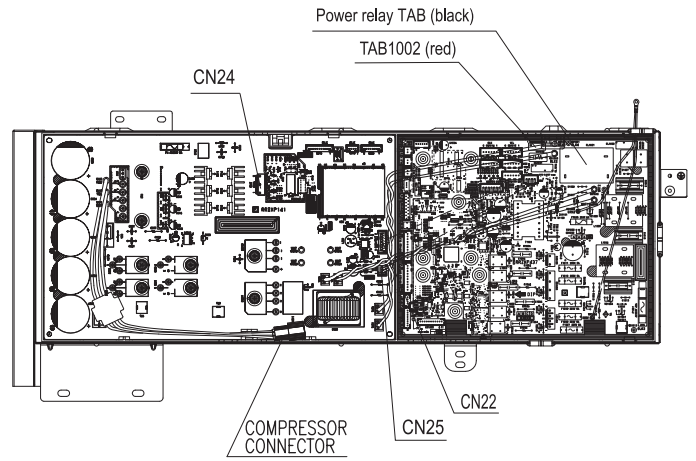

- (2) Remove screw (8 pieces) that fixed the board.

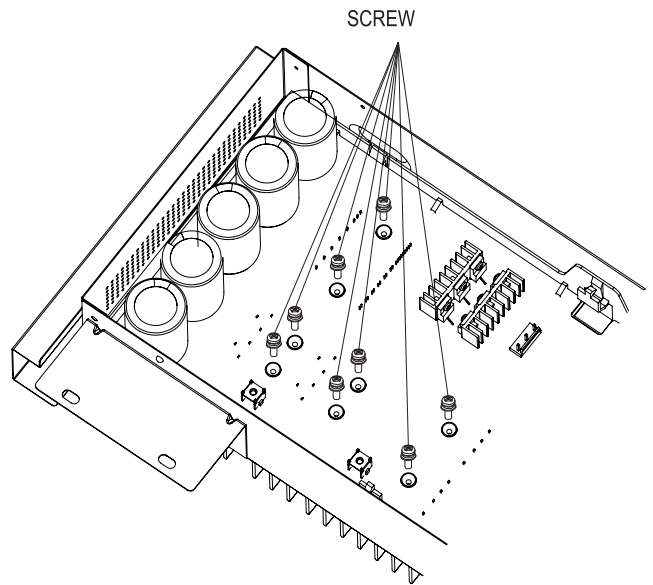

- (3) Take out the board by lift up after release the hook that hold the board in its place.

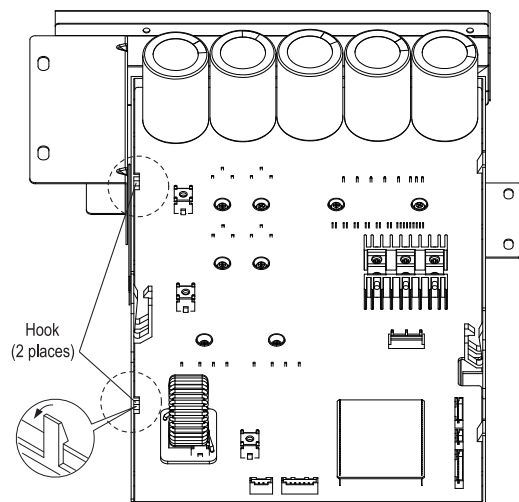

(4) Remove the screw (11 places) that fixed the cabinet then remove the cabinet.

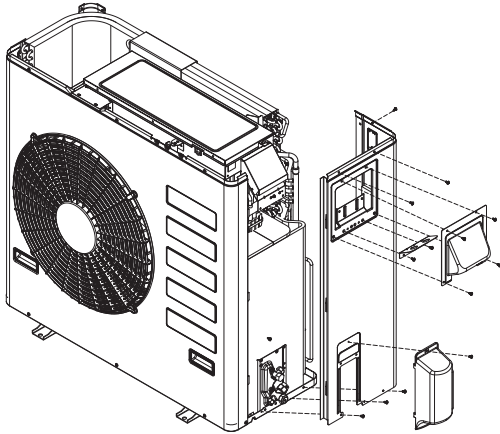

(5) Un-insert the TAB terminal (2 places) that fixed to the reactor.

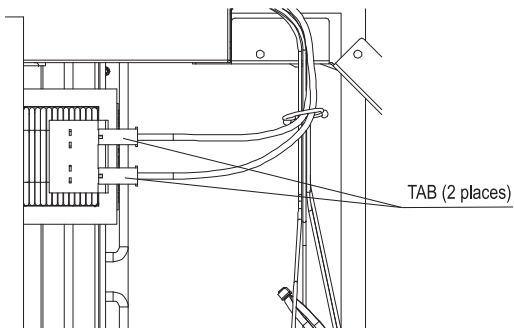

5. Assembly procedure of inverter board

(1) Preparation before insert back the board.

Applied silicon uniformly with small amount to 7 places of electronic part at back side of board.
Then fix back the insulation sheet (2 places).

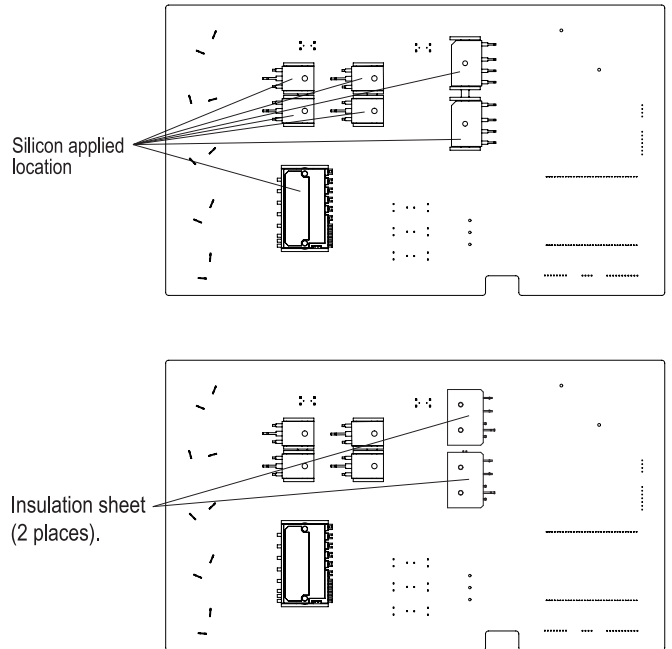

(2) Insert the board into the pcb support and fix it with hooks (2 places).

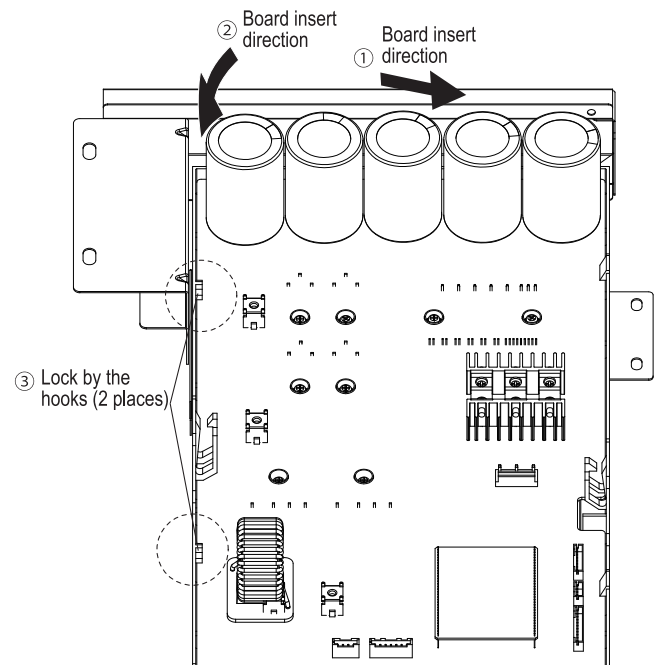

(3) Arrange the board position so that hole for fixing screw and holes at heat sink are concentric.

Arrange hole position (8 places).

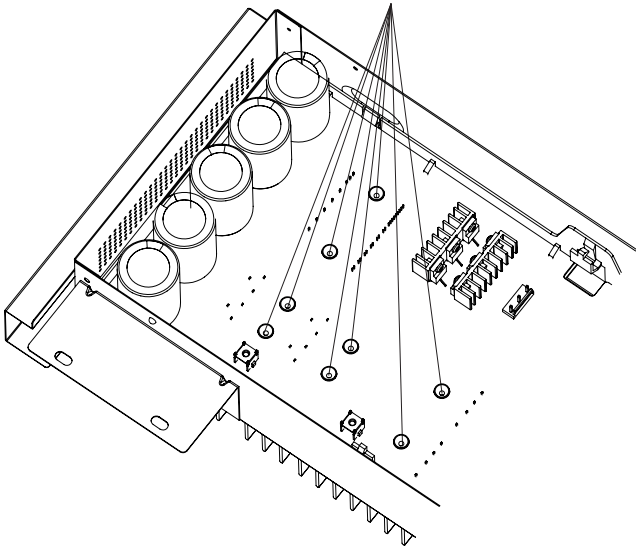

(4) Fix the board with screw (8 pieces).

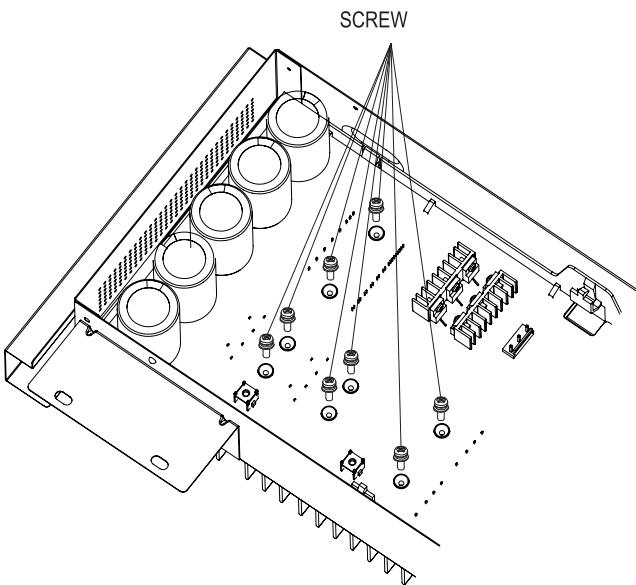

(5) Insert back connector (4 places) and 2 TAB terminal

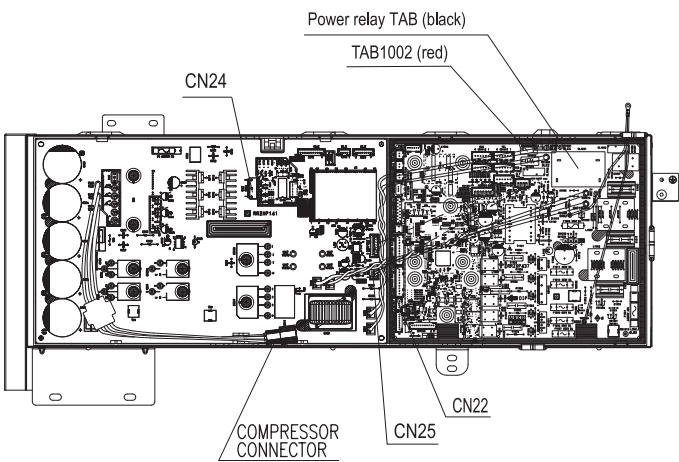

(6) Insert back TAB (2 places) to the reactor.

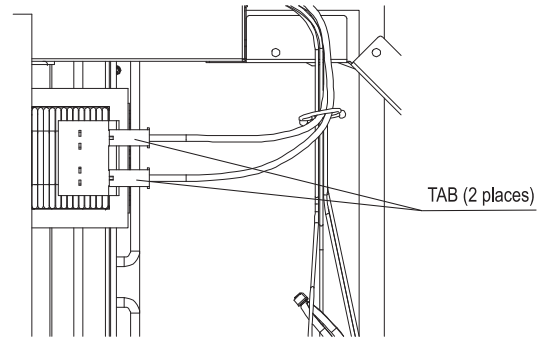

(7) Fix back the cabinet with screw (11 places).

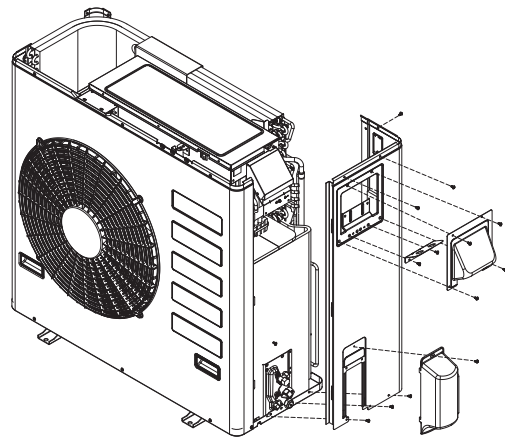

SELF CHECK

When it is difficult to judge whether the compressor or the electrical part is faulty resulting self diagnosis lamp LD1351 blink 2,3,4 or 5 times, please confirm first the compressor terminal insulation by using mega ohm checker. If the insulation is normal, proceed to below self-check method.

Self-check diagnosis method

1. Switch OFF main power supply. (Wait until DC voltage fully discharged :15 minutes or more)
2. Short circuit between JW1001 & JW1002.
3. Switch ON main power supply. (LD1352 will blink 1 time)
4. Press and hold TEST SWITCH for more than 1 second.
5. Self-check diagnosis result will appear.
 - The content of diagnosis result shall refer to below table.

Self-check diagnosis result

[SELF-CHECK] DIAGNOSIS RESULT		
LD301	DIAGNOSIS CONTENT	REPAIR METHOD
1 TIME BLINK	ELECTRICAL OK	CHANGE COMPRESSOR
2 TIMES BLINK	PEAK CURRENT CUT OFF SIGNAL DETECTED	CHANGE INVERTER P.W.B
7 TIMES BLINK	COMPRESSOR CURRENT ABNORMAL	COMPRESSOR CONNECTOR LOOSE → CHECK CONNECTOR AFTER CHECK COMPRESSOR CHANGE INVERTER P.W.B
10 TIMES BLINK	DC VOLTAGE ABNORMAL	AC VOLTAGE ABNORMAL (BEYOND RATED $\pm 10\%$) ↳ CONNECT WITH CORRECT AC VOLTAGE AC VOLTAGE NORMAL (WITHIN RATED $\pm 10\%$) ↳ CONNECTOR (CN1033, CN25) BAD INSERTION → CHECK CONNECTOR OTHER → CHANGE BOTH MAIN & INVERTER P.W.B
13 TIMES BLINK	EEPROM READING ERROR	CHANGE BOTH MAIN & INVERTER P.W.B

In case abnormality found at the checking result, please confirm the connecting cord having problem or not before replace the defect part according to the table of self-check diagnosis result.

In case no abnormality found at electrical part, release back JW1001 & JW1002 to original condition (no short circuit condition) before it can be use.

※If forgot to release back JW1001 & JW1002 to original condition, the system will operate as below condition after power supply restored.

Time after power restored	Unit condition
Below than 3 minutes	Indoor timer lamp will 12 times blinking (show error - outdoor communication circuit failure).
3 ~ 6 minutes	Can run as normal.
After 6 minutes	Unit enter hibernation mode. Can run as normal.

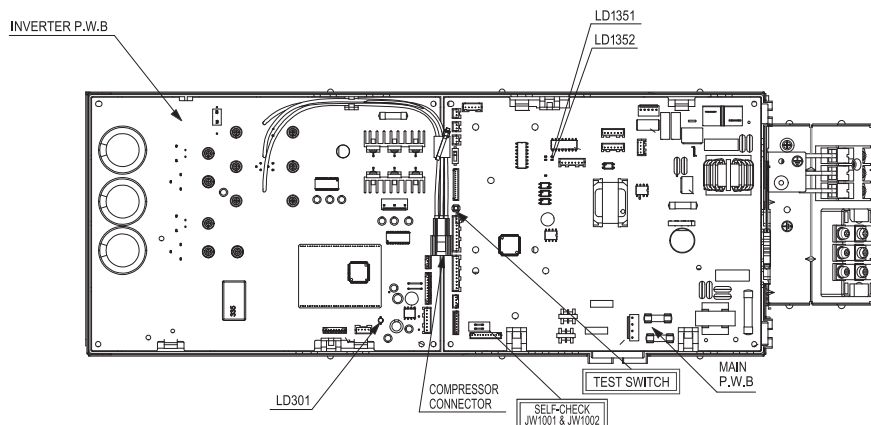

Collect refrigerant using test switch operation

1. Turn OFF the breaker and wait for 1 minute or more before turn ON back the breaker.
2. Detach the electrical cover of outdoor unit and ensure LD1353 is blinking once.
3. Wait 20 seconds or more before pressing the test switch for 1 second or more to start the forced cooling operation.
4. Pressing the test switch again for 1 second or more will stop the operation.

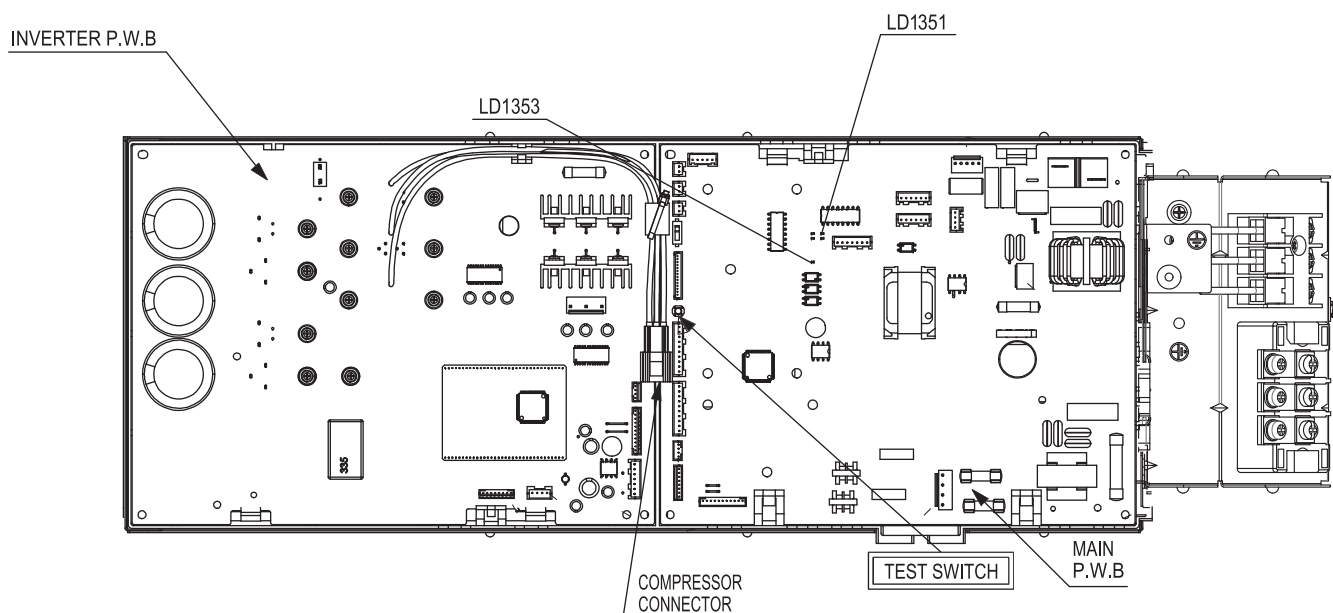

■ Cautions

1. Do not in any circumstances operate the outdoor unit for more than 5 minutes.
2. Doing work with the compressor connector removed will cause the LD1351 to blink 4 times. It will not start the operation.
3. For another test run, turn OFF the breaker and turn it back ON to reset the power supply. (The test switch is accepted only once after power ON. After operation by remote controller, it is not accepted.)
4. When the operation with the test switch is done, turn OFF the breaker.

How to operate the outdoor unit independently

1. Connect the large dia. pipe side and small dia. pipe side service valves using a pipe.

Connect the small diameter service valve and the large diameter service valve using the reducing union and copper pipe as shown on the right.

Charge refrigerant of 300g after vacuuming (※1)

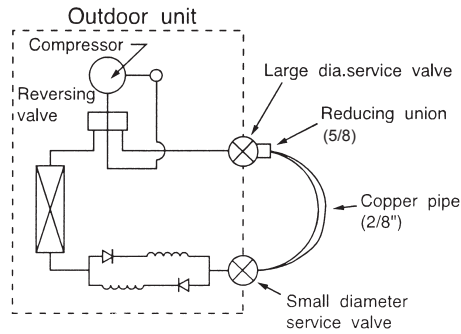

Parts to be prepared

- (1) Reducing union
2/8" (6.35mm)
5/8" (15.88mm)
- (2) Copper pipe (2/8" and 3/8")

Do not operate more than 5 minutes

The operation method is the same as "Collect refrigerant using test switch".

※1 The charging amount of 300g is equivalent to the load in normal operation.

Lighting mode of the self-diagnosis lamp

1 Mounting location of the self-diagnosis lamp

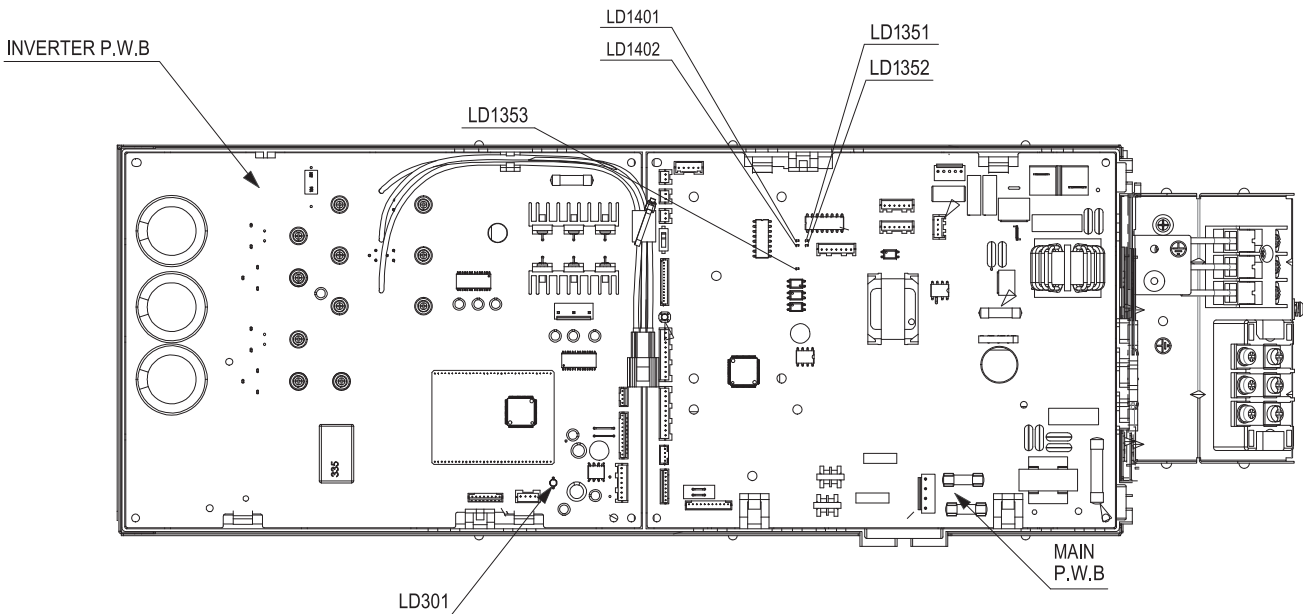

SELF-DIAGNOSIS DISPLAY MODE (INDOOR SIDE) MODEL RAS-EH36PHLAE

While the "timer lamp" (orange), of the indoor unit is blinking, troubleshoot the product while referring to the table below.

- How to count the lamp blinking frequency
 - The product will repeat blinking with 2-second intermissions.
 - The blinking speed is as follows: on for 0.35 seconds and off for 0.35 seconds.

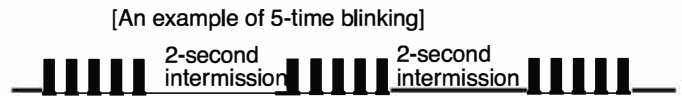

- If you wish to try another operation while the lamp is blinking, operate the START/STOP button on the remote control unit twice. The first push will reset the indoor microcomputer, while the second will activate the product

Refer to the table below if the timer indicator (orange) is blinking.

LAMP BLINKING MODE	MAIN DEFECTIVE
ONCE	REFRIGERANT CYCLE DEFECTIVE
2 TIMES	FORCED OPERATION OF OUTDOOR UNIT
3 TIMES	INDOOR INTERFACE CIRCUIT
4 TIMES	OUTDOOR ELECTRICAL ASSEMBLY DEFECT
9 TIMES	ROOM OR HEAT EXCHANGER THERMISTOR OR HUMIDITY SENSOR DEFECT
10 TIMES	OVERCURRENT IN DC FAN MOTOR
12 TIMES	OUTDOOR INTERFACE CIRCUIT
13 TIMES	IC531 OR EEPROM DATA DEFECT
(- LIGHT FOR 0.35 SEC AT INTERVAL OF 0.35 SEC)	

- * IF THE INTERFACE CIRCUIT IS DEFECTIVE WHEN THE POWER IS TURNED ON. THE SELF-DIAGNOSIS INDICATION WILL NOT WORK.
- * IF THE INDOOR UNIT CAN NOT BE OPERATED AT ALL.

REFER TO THE BELOW TABLE IF THE INDOOR UNIT DOSE NOT WORK AT ALL.

FIX CN2 CONNECTOR	ACTION /REPLACEMENT PARTS, etc
FU1 (3.15A) FUSE BLOWN	REPLACE THE PART WHICH CAUSED BLOWING/DISCONNECTION OF FU1(3.15A) FUSE
COME OFF OR DISCONNECTION OF THE CONNECTOR FOR INDICATING P.W.B	FIX CN16 CONNECTOR
FAILURE OF CONTROL P.W.B	REFER TO THE SERVICE GUIDE FOR HOW TO DETERMINE THE FAILED PART

Lighting mode of the self-diagnosis lamp

2 Lighting mode of the self-diagnosis lamp

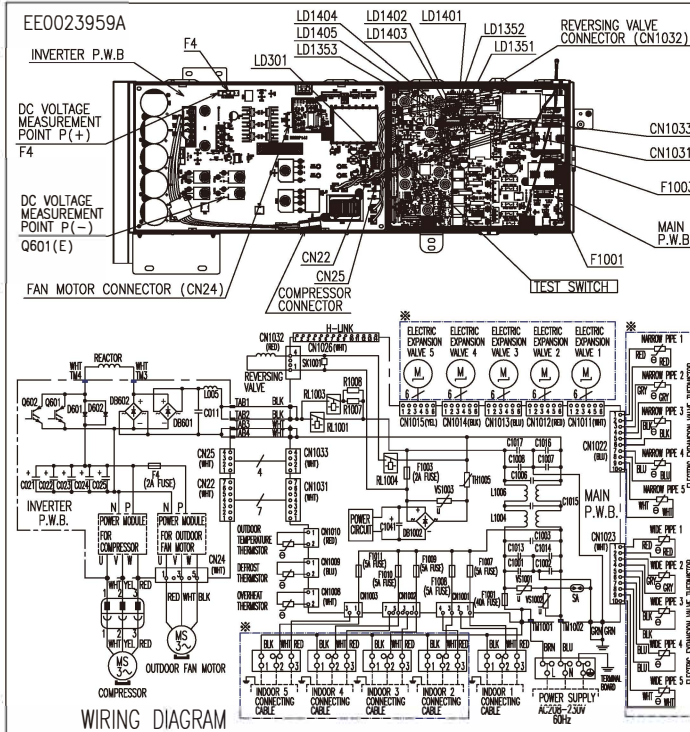

LED INDICATION DURING OPERATION			
LED	STATUS	SELF-DIAGNOSE CONTENT	REPAIR METHOD
LD1353	ON	NORMAL	NORMAL (BLINKING TIMING IS IRREGULAR)
	STANDBY	NORMAL	LED WILL OFF DURING STANDBY MODE.
	OFF	OTHER THAN STANDBY	NO POWER SUPPLY AT TERMINAL "L - N" → CHECK POWER CABLE. CIRCUIT DEFECT. → CHANGE BOTH MAIN & INVERTER P.W.B.
LD1401 (INDOOR 1) LD1402 (INDOOR 2) LD1403 (INDOOR 3) LD1404 (INDOOR 4) LD1405 (INDOOR 5)	LIT	ABNORMAL	CIRCUIT DEFECT. → CHANGE BOTH MAIN & INVERTER P.W.B.
	OFF	CONNECTING	CONNECTED NORMALLY WITH INDOOR UNIT.
LD1353	1 TIME BLINK	COMMUNICATION ERROR BETWEEN INDOOR/OUTDOOR	CONNECTING CABLE DISCONNECTED → CHANGE CONNECTING CABLE. CONNECTING CABLE MISCONNECTION → ADJUST CONNECTING CABLE. F1007~ F1011 (5A FUSE) BLOWN → CHANGE FUSE AFTER CHECK CABLE. COMMUNICATION CIRCUIT DEFECT. → CHANGE BOTH MAIN & INVERTER P.W.B.
	OFF	STANDBY	LED WILL OFF DURING STANDBY MODE.
LD1353	OFF	OTHER THAN STANDBY	INDOOR UNIT IS NOT CONNECTED. IF ALREADY CONNECTED, CONFIRM ABOVE 1 TIME BLINK CHECKING POINT.

* SOME MODELS NOT NEED TO INSTALL THE PARTS IN DASH DOT.

⚠ DANGER ⚠ Electric shock risk (DC360V)
PLEASE WAIT AT LEAST 15 MINUTES FOR THE VOLTAGE TO DROP.
MEASURE DC VOLTAGE (BETWEEN TERMINAL P & N) AND CONFIRMED THAT IT IS BELOW 10V THEN ONLY CAN START THE SERVICING WORK.

LED INDICATION DURING STOP																																							
LD1351	LD1352	SELF-DIAGNOSE CONTENT	CHECKING POINT																																				
OFF	OFF	NO POWER SUPPLY	NO POWER SUPPLY AT TERMINAL "L - N". → CHECK POWER CABLE. CONNECTING CABLE MISCONNECTION. → CHECK CONNECTING CABLE. F1003 (2A FUSE) BLOWN. → CHANGE BOTH MAIN & INVERTER P.W.B. CIRCUIT DEFECT. → CHANGE BOTH MAIN & INVERTER P.W.B.																																				
		NORMAL STOP	NOT MALFUNCTION																																				
LIT	BLINK	THERMISTOR ABNORMAL	<table border="1"> <thead> <tr> <th>BLINK</th> <th>ABNORMAL LOCATION</th> <th>BLINK</th> <th>ABNORMAL LOCATION</th> </tr> </thead> <tbody> <tr> <td>1 TIME</td> <td>OH THERMISTOR</td> <td>9 TIMES</td> <td>ELECTRIC EXPANSION VALVE 3</td> </tr> <tr> <td>2 TIMES</td> <td>DEF THERMISTOR</td> <td>10 TIMES</td> <td>ELECTRIC EXPANSION VALVE 4</td> </tr> <tr> <td>3 TIMES</td> <td>OUTDOOR THERMISTOR</td> <td>11 TIMES</td> <td>ELECTRIC EXPANSION VALVE 5</td> </tr> <tr> <td>4 TIMES</td> <td>INDOOR P.W.B. 1</td> <td>12 TIMES</td> <td>THERMISTOR NARROW PIPE 2</td> </tr> <tr> <td>5 TIMES</td> <td>ELECTRIC EXPANSION VALVE 2</td> <td>13 TIMES</td> <td>THERMISTOR NARROW PIPE 3</td> </tr> <tr> <td>6 TIMES</td> <td>INDOOR P.W.B. 2</td> <td>14 TIMES</td> <td>THERMISTOR WIDE PIPE 1</td> </tr> <tr> <td>7 TIMES</td> <td>THERMISTOR WIDE PIPE 2</td> <td>15 TIMES</td> <td>THERMISTOR WIDE PIPE 2</td> </tr> <tr> <td>8 TIMES</td> <td>THERMISTOR WIDE PIPE 3</td> <td>16 TIMES</td> <td>THERMISTOR WIDE PIPE 5</td> </tr> </tbody> </table>	BLINK	ABNORMAL LOCATION	BLINK	ABNORMAL LOCATION	1 TIME	OH THERMISTOR	9 TIMES	ELECTRIC EXPANSION VALVE 3	2 TIMES	DEF THERMISTOR	10 TIMES	ELECTRIC EXPANSION VALVE 4	3 TIMES	OUTDOOR THERMISTOR	11 TIMES	ELECTRIC EXPANSION VALVE 5	4 TIMES	INDOOR P.W.B. 1	12 TIMES	THERMISTOR NARROW PIPE 2	5 TIMES	ELECTRIC EXPANSION VALVE 2	13 TIMES	THERMISTOR NARROW PIPE 3	6 TIMES	INDOOR P.W.B. 2	14 TIMES	THERMISTOR WIDE PIPE 1	7 TIMES	THERMISTOR WIDE PIPE 2	15 TIMES	THERMISTOR WIDE PIPE 2	8 TIMES	THERMISTOR WIDE PIPE 3	16 TIMES	THERMISTOR WIDE PIPE 5
BLINK	ABNORMAL LOCATION	BLINK	ABNORMAL LOCATION																																				
1 TIME	OH THERMISTOR	9 TIMES	ELECTRIC EXPANSION VALVE 3																																				
2 TIMES	DEF THERMISTOR	10 TIMES	ELECTRIC EXPANSION VALVE 4																																				
3 TIMES	OUTDOOR THERMISTOR	11 TIMES	ELECTRIC EXPANSION VALVE 5																																				
4 TIMES	INDOOR P.W.B. 1	12 TIMES	THERMISTOR NARROW PIPE 2																																				
5 TIMES	ELECTRIC EXPANSION VALVE 2	13 TIMES	THERMISTOR NARROW PIPE 3																																				
6 TIMES	INDOOR P.W.B. 2	14 TIMES	THERMISTOR WIDE PIPE 1																																				
7 TIMES	THERMISTOR WIDE PIPE 2	15 TIMES	THERMISTOR WIDE PIPE 2																																				
8 TIMES	THERMISTOR WIDE PIPE 3	16 TIMES	THERMISTOR WIDE PIPE 5																																				
1 TIME BLINK		RESET STOP	WAITING COMPRESSOR TO START. → NORMAL OTHER. → IF STILL NOT SOLVE AFTER CHECK THE CONNECTING CABLE, CHANGE MAIN P.W.B.																																				
2 TIMES BLINK		PEAK CURRENT CUT	SERVICE VALVE NOT OPEN. → CHECK SERVICE VALVE. COMPRESSOR CONNECTOR NOT CONNECTED. → CHECK CONNECTOR.																																				
3 TIMES BLINK		INDOOR LOW SPEED ROTATION	IF NO ISSUE WITH ABOVE CHECKING POINT AND AFTER CHECK THE COMPRESSOR INSULATION, PROCEED TO [SELF-CHECK] DIAGNOSIS.																																				
4 TIMES BLINK		SWITCHING FAILURE	OUTDOOR UNIT SURROUNDING IS BLOCKED. → REMOVE THE CAUSE OF BLOCKING. OTHER. → CHECK REFRIGERANT CYCLE.																																				
5 TIMES BLINK		OVERLOAD LOWER LIMIT CUT	SERVICE VALVE NOT OPEN. → CHECK SERVICE VALVE. REFRIGERANT LEAK. → CHECK REFRIGERANT CYCLE AND RE-CHARGE IT. BAD COMPRESSOR CONNECTOR INSERTION. → CHECK CONNECTOR.																																				
6 TIMES BLINK		COMPRESSOR TEMPERATURE RISE	CIRCUIT DEFECT. → CHANGE MAIN P.W.B.																																				
8 TIMES BLINK		COMMUNICATION ERROR BETWEEN MAIN	BAD CONNECTOR INSERTION (CN1031, CN22). → CHECK CONNECTOR INSERTION. OTHER. → CHANGE BOTH MAIN & INVERTER P.W.B.																																				
9 TIMES BLINK		INDOOR TYPE MISMATCH (SINGLE/MULTI)	REFER LD1401~LD1405, CHECK INDOOR TYPE → REPLACE INDOOR P.W.B. OR INDOOR UNIT.																																				
10 TIMES BLINK	OFF	POWER SUPPLY VOLTAGE ERROR	ABNORMAL (BEYOND RATED VOLTAGE ±10%). → SUPPLY CORRECT VOLTAGE. NORMAL (WITHIN RATED VOLTAGE ±10%). → BAD CONNECTOR INSERTION (CN1033, CN25) → CHECK CONNECTOR INSERTION. OTHER. → CHANGE BOTH MAIN & INVERTER P.W.B.																																				
11 TIMES BLINK		FAN STOP BY STRONG WIND	TEMPORARY STOP DUE TO STRONG WIND. → FAN WILL ROTATE AGAIN AFTER WIND BECOME WEAK.																																				
12 TIMES BLINK		FAN LOCK STOP	TEMPORARY STOP DUE TO STRONG WIND. → FAN WILL RESTART MOVING LATER. PROPELLER FAN LOCK. → REMOVE THE THING THAT BLOCKING THE FAN. CONDUCT OUTDOOR FAN MOTOR CHECK. → REPLACE THE DEFECT PART																																				
13 TIMES BLINK		EEPROM READING ERROR	LD301 ALSO BLINK 13 TIMES. → CHANGE BOTH MAIN & INVERTER P.W.B. OTHER. → CHANGE MAIN P.W.B.																																				
14 TIMES BLINK		DC VOLTAGE ABNORMAL	CONFIRM AC POWER SUPPLY & DC VOLTAGE IS NORMAL. → CHANGE INVERTER P.W.B. COMPRESSOR LOAD ABNORMAL. → INSPECT THE COMPRESSOR																																				
15 TIMES BLINK		CIRCUIT ABNORMAL	CHANGE INVERTER P.W.B.																																				
16 TIMES BLINK		HIGH LOAD DURING STOP	SOMETHING BLOCKED SURROUND OUTDOOR UNIT → REMOVE THE CAUSE OF BLOCKING DUST ON INDOOR UNIT FILTER → CLEAN UP THE FILTER																																				

LED INDICATION DURING COMPRESSOR OPERATE	
LD301	OPERATION STATUS
LIT	NORMAL
BLINK REPEATINGLY WITH 2 SECONDS LIT - 0.3 SECONDS OFF	OVERLOAD (NORMAL)

DURING UNIT STOP, TO DETERMINE WHETHER THE COMPRESSOR OR THE ELECTRICAL IS FAULTY WHEN SELF-DIAGNOSIS BLINK 2, 3, 4 OR 5 TIMES HAPPEN, CONFIRM THE COMPRESSOR TERMINAL INSULATION BY USING MEGA OHM CHECKER. IF THE INSULATION IS NORMAL, PROCEED TO BELOW [SELF-CHECK] METHOD.
TAKE NOTE THAT DURING [SELF-CHECK], THERE ARE POSSIBLY LOUD SOUND FROM IPM CAN BE HEARD IN THE CASE OF IPM IS BROKEN.

[SELF-CHECK] DIAGNOSIS METHOD	
1.	SWITCH OFF MAIN POWER SUPPLY.
2.	SWITCH ON MAIN POWER SUPPLY.
3.	PRESS AND HOLD THE TEST SWITCH AT OUTDOOR FOR MORE THAN 5 SEC, UNTIL LD1351 FAST BLINKS AND THEN RELEASE THE TEST SWITCH.
4.	SELF-CHECK RESULT WILL DISPLAY LD301. REFER TO BELOW TABLE FOR THE DETAIL OF THE DIAGNOSIS RESULT.
5.	SWITCH OFF MAIN POWER SUPPLY ONCE DONE.

[SELF-CHECK] DIAGNOSIS RESULT		
LD301	DIAGNOSIS CONTENT	REPAIR METHOD
1 TIME BLINK	ELECTRICAL OK.	CHANGE COMPRESSOR.
2 TIMES BLINK	PEAK CURRENT CUT OFF SIGNAL DETECTED.	CHANGE INVERTER P.W.B.
7 TIMES BLINK	COMPRESSOR CURRENT ABNORMAL.	COMPRESSOR CONNECTOR LOOSE → CHECK CONNECTOR. AFTER CHECK COMPRESSOR CHANGE INVERTER P.W.B.
10 TIMES BLINK	DC VOLTAGE ABNORMAL.	AC VOLTAGE ABNORMAL (BEYOND RATED ±10%) → CONNECT WITH CORRECT AC VOLTAGE. AC VOLTAGE NORMAL (WITHIN RATED ±10%) → CONNECTOR (CN1033) BAD INSERTION → CHECK CONNECTOR OTHER → CHANGE BOTH MAIN & INVERTER P.W.B.
13 TIMES BLINK	EEPROM READING ERROR.	CHANGE INVERTER P.W.B.

[OUTDOOR FAN MOTOR CHECK] DIAGNOSIS METHOD	
1.	SWITCH OFF MAIN POWER SUPPLY.
2.	UN-INSERT OUTDOOR FAN MOTOR CONNECTOR CN24.
3.	MAKE SURE NO ABNORMALITIES AT THE FAN SHAFT.
4.	MEASURE RESISTANCE AT FAN MOTOR CONNECTOR CONTACT. NORMAL RESISTANCE BETWEEN EACH TERMINAL SHALL BE NEARLY SAME. MOTOR NORMAL : CHANGE INVERTER P.W.B. MOTOR ABNORMAL : CHANGE FAN MOTOR AND INVERTER P.W.B. (IF REQUIRED)

OTHERS CHECKING POINT

- REVERSING VALVE NOT OPERATE
=> UN-INSERT THE CONNECTOR AND CHECK THE LEAD WIRE.
=> IF OK, CHECK REVERSING VALVE COIL.
- COMMUNICATION ERROR OR OUTDOOR UNIT NO OPERATION
=> CHECK CONNECTING CABLE BETWEEN INDOOR AND OUTDOOR UNIT.

14 TROUBLE SHOOTING

PRECAUTION FOR CHECKING



DANGER

1. Remember that the 0V line is biased to 162V in reference to the ground level.
2. Also noted that it takes about 15 minutes until the voltage fall after the power switch is turned OFF.

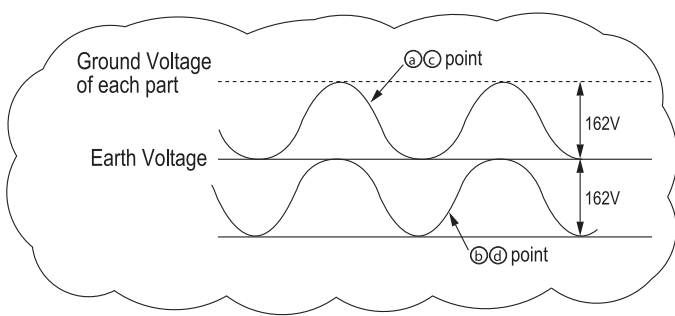
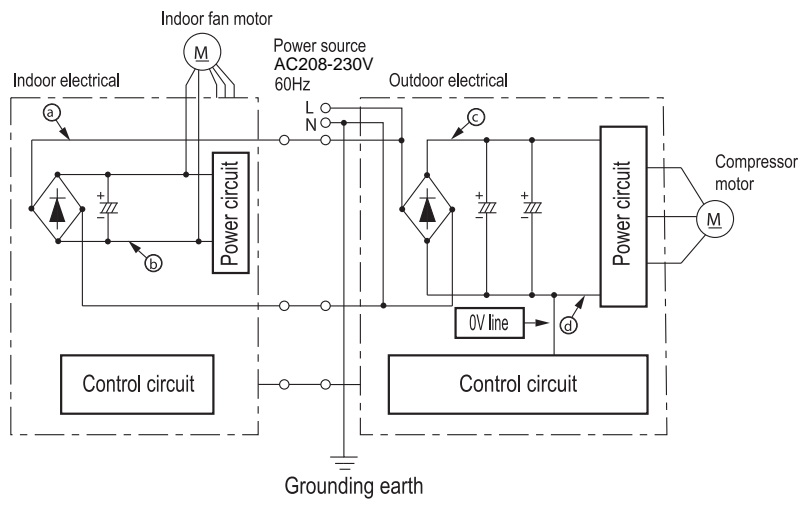
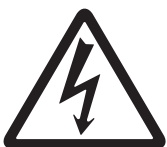

DANGER



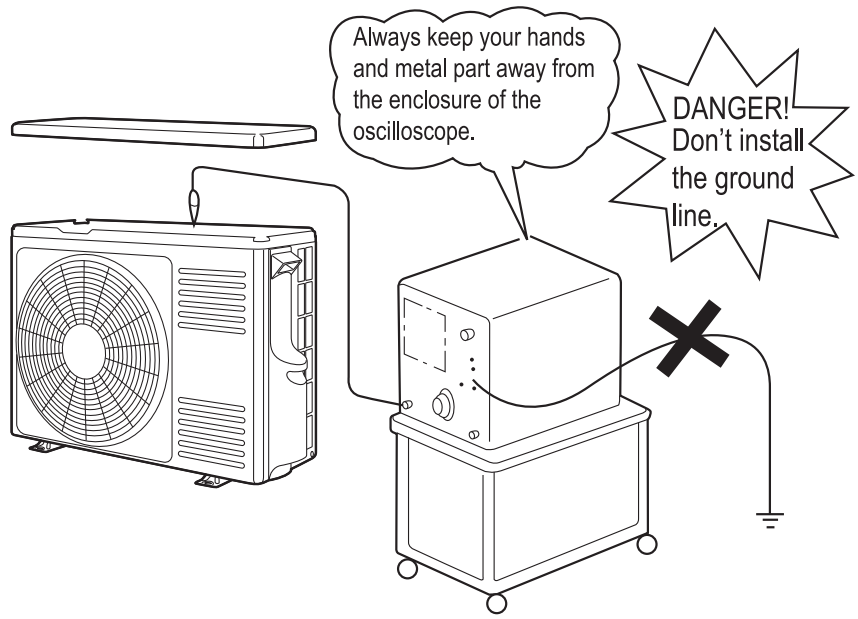

When using an oscilloscope, never ground it. Don't forget that high voltages as noted above may apply to the oscilloscope.









Self Diagnosis Memory Function

Failure mode are stored in the non-volatile memory of indoor unit and can be redisplay by operating the remote controller. This function is very useful in checking the failure modes when either unintentionally switching OFF power supply or restarting the unit operation without conforming the number of blinking of self diagnosis lamp. Remote controller can be redisplay up to last 5 failure modes from the memory. However, failure modes which are rarely occur are also stored in the memory which caused the number of failure easily become more than 5. Thus, for some failure modes which are unable to retrieve because of the remote controller limit to redisplay only 5 failure modes, it can be found by clearing up the memory first then recheck the memory content again during the visit at the customer place.





<How to redisplay failure diagnosis>

1. Turn OFF the circuit breaker on the unit side. (wait for around 5 sccond)
2. Press the [ (MODE)] button and select [Cool mode ()]. The remote should be in 'Standby' mode.
3. Turn the circuit breaker ON.
4. Set the room temperature on the remote controller to 32° C by pressing the [ (Temp Up)] button.
5. Set which failure information that need to be redisplay by using [ (Fan Speed)] button.
(Refer to the corresponding table below)

Fan Speed	Failure data stored
Auto 	Latest
Hi 	2nd latest
Med 	3rd latest
Lo 	4th latest
Silent 	Oldest

6. While directing the remote controller towards the receiver of the indoor unit, press [ (Temp Up)] button and [ (On/Off)] button simultaneously.
(The remote controler perform signal transmission with the indoor unit)
7. The indoor unit beep [Pi-] to indicate that it has just received the signal to redisplay the failure mode.
8. Start counting the number of blinking of the Timer lamp (indicating indoor error) and Operation lamp (indicating outdoor error) and confirm it with indoor unit or outdoor unit self-diagnosis table.
9. After everything is completed, turn OFF the circuit breaker (must do without fail).









<How to clear the stored data>

1. Conduct the redisplay of failure mode. (Follow above procedure)
2. Turn the circuit breaker OFF. (Wait for 5sec or more)
3. Press the [ (MODE)] button and select [Dry mode ()]. The remote should be in 'Standby' mode.
4. Turn the circuit breaker ON.
5. Set the room temperature on the remote controller to 16° C by pressing the [ (Temp Down)] button.
6. While directing the remote controller towards the receiver of the indoor unit, press [ (Temp Down)] button and [ (On/Off)] button simultaneously.
(The remote controller perform signal transmission with the indoor unit.)
7. The indoor unit beep for a few second [Pi-] to indicate that it has just receive the signal. The data has been cleared.
8. After everything is completed, turn OFF the circuit breaker (must do without fail).





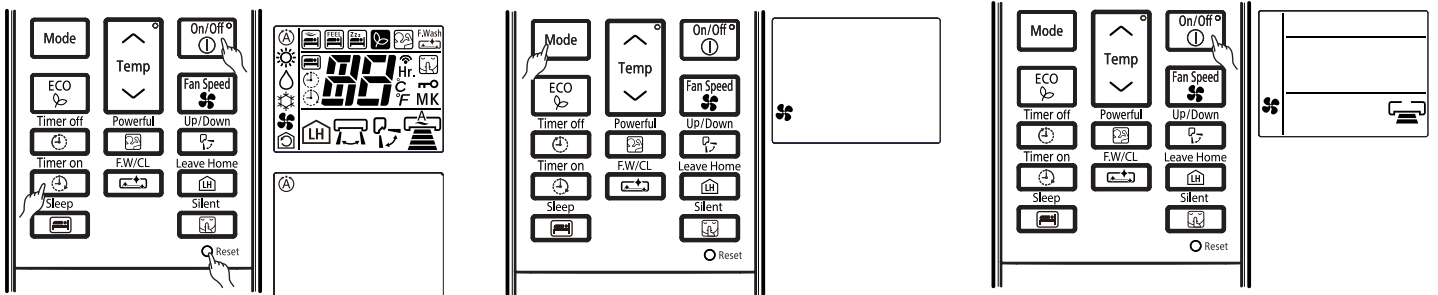

Notes:

- * This function is valid only once right after the power supply is turned ON and it will not work if other remote controller operation was made prior to it.
Also, this function will not work if above steps were not followed accordingly. (If the above procedures are not working, please repeat from the start.)
- * If nothing was stored in the memory, the lamp does not blink even the redisplay operation is carried out.
- * To carry out normal operation, turn OFF the power supply. After redisplay operation, the remote controller reception will not work as normal.

HOW TO CHANGE THE SHIFT VALUE SETTING TEMPERATURE

1. While pressing and holding  (ON/OFF) button and  button, press RESET  [RESET] button on the same. Release RESET  [RESET] button only and make sure that all marks on the remote controller display are indicated then release the  (ON/OFF) button and  button. Remote controller now enters "Shift Value Change Mode".
2. Press the  (MODE) selector button so that the display indicates  (FAN) mode.
3. Press the  (ON/OFF) button and FAN operation will be started.



4. Set the FAN SPEED with the  (FAN SPEED) button according to the following FAN speed setting in order to choose the desired operation mode that is required for shift value setting temperature modification.
 - To change the shift value for COOLING mode operation, select either  (HIGH) or  (MED) FAN SPEED
 - To change the shift value for HEATING mode operation, select either  (LOW) or  (SILENT) FAN SPEED
5. Press the (TEMP  or ) button to change the shift value. (The shift value changed with device producing beep sound.)

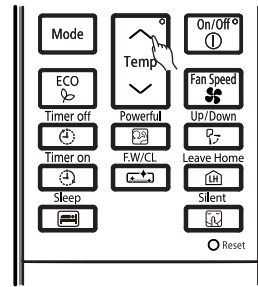
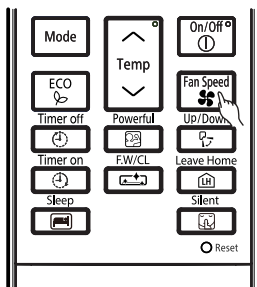

Transmission sign lights up with beep from device simultaneously.

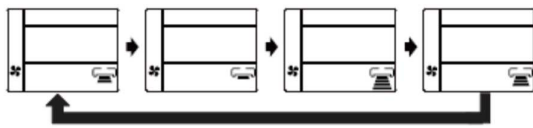

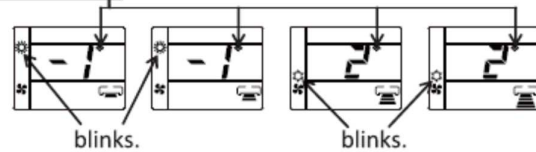

Step 4

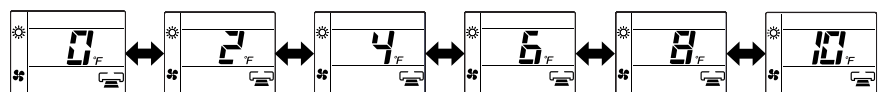
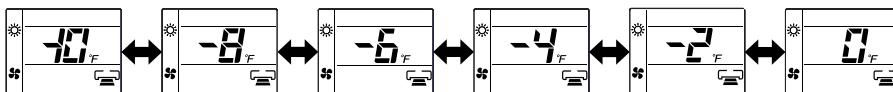

Step 5



NOTE :

1. The displayed shift value,  (HEAT) and  (COOL) symbol on the remote controller display will disappear after 10 seconds.
2. The changed shift value will remain unchanged after turned off the power.
3. If "0" is displayed on the remote controller display, it indicates the shift value is now at the initial setting.

SETTING THE PREVENTION OF MUTUAL INTERFERENCE FOR REMOTE CONTROLLER

a.) Other indoor circuit breakers should be disconnected.



b.) Remove the back cover of the remote control.

c.) Cut the jumper as shown below.

d.) Press "Reset" button after installing the battery.

e.) Corresponding to the room electrical box dial code 6 to dial on.



Cut (Attention: Remove the battery before cutting. Do not cut with electricity).





f.) Please use the remote control to check the available models of corresponding indoor machines.

HOW TO CHANGE THE FAN SPEED IN COOLING MODE DURING THERMO OFF

The fan speed in Cooling Mode during thermo off can be changed by the remote controller.
 (This procedure shall be implemented strictly by service personnel only.)
 It is possible to return it to the default setting.

PROCEDURE

Press  [POWERFUL] button and  [ECO] button simultaneously for about 5 seconds when the remote controller is OFF.

Transmission sign lights up with beep from indoor unit simultaneously.

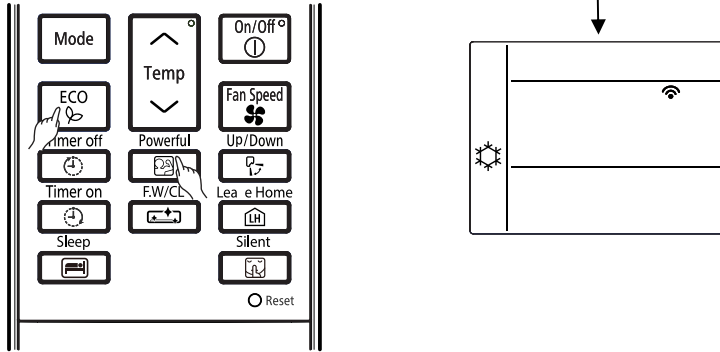

- Beep sound pattern :
- 1) Default setting : Short beep
 - 2) Changed setting : Double beep

	Fan speed during thermo off
Default Setting	Ultra low
Changed Setting	Set fan speed (When auto fan speed is set, the fan speed is low)

NOTE:



- (1) The selected fan speed will remain unchanged after the unit is turned off.
- (2) If Timer reservation has been set, it will be canceled.
- (3) During time setting and timer setting, this operation cannot be set.

HOW TO CHANGE THE INTERMITTENT FAN HEATING SETTING



The intermittent fan control during thermo off in Heating mode can be changed by the remote controller. (The procedure should be done only by service personnel.)

It is possible to select from 3 patterns.

PROCEDURE



Press  (POWERFUL) button,  (FAN SPEED) button and press  [RESET] button simultaneously.

Release  [RESET] button only and make sure that all marks on the remote controller display are indicated, then release

 (POWERFUL) button and  (FAN SPEED) button.

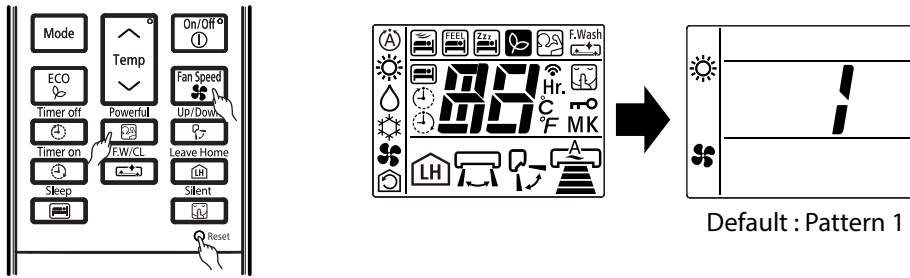
Remote controller now enters "Intermittent Fan Control Change Mode".



Press [ROOM TEMPERATURE setting] [ (UP) /  (DOWN)] button.

(The intermittent pattern changed with indoor unit beep sound)

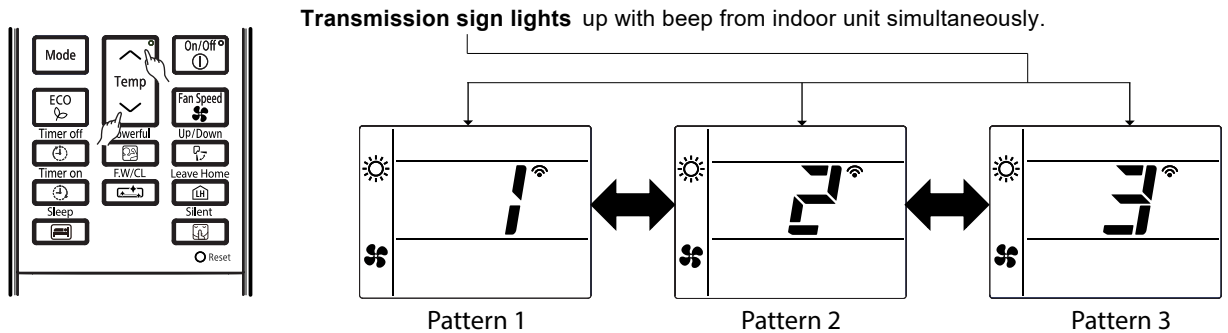

	Pattern 1	Pattern 2	Pattern 3
Single model	Continuous	30sec ON / 210sec OFF repeatedly	50sec ON / 190sec OFF repeatedly
Multi	30sec ON / 210sec OFF repeatedly	50sec ON / 190sec OFF repeatedly	Continuous









NOTE:

- (1) The indication of the selected intermittent pattern will disappear after 10 seconds.
- (2) The selected intermittent pattern will remain unchanged after the unit is turned off.



DISPLAY OPERATION MODE SETTING

For operating indoor unit independently (without outdoor unit connection), remote controller must be set according to below procedures before send the signal to the indoor unit. New communication format between indoor and outdoor is required to communicate with outdoor unit.

PROCEDURE

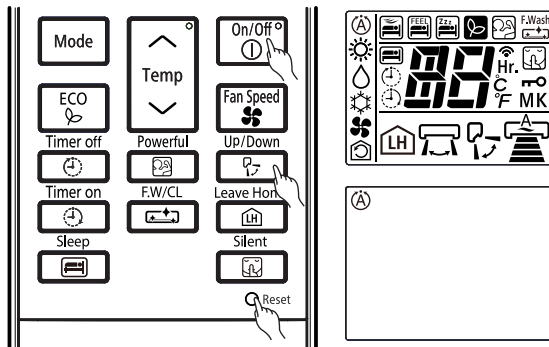
1. While pressing and holding the  (ON/OFF) button and  (UP/DOWN) button, press  (RESET) button on same time. Release  (RESET) button only and make sure that all marks on the LCD display are indicated, then release the  (ON/OFF) button and  (UP/DOWN) button. Remote controller now enters "DISPLAY OPERATION MODE" for the indoor unit to run independently. Please ensure these ensure that  (FAN SPEED) when pressing button, "" will be blinking.



2. Press the  (MODE) selector button to choose the desired operation mode.
3. Press  (ON/OFF) button.
Then, the indoor unit will start to operate independently according to the selected operation mode.

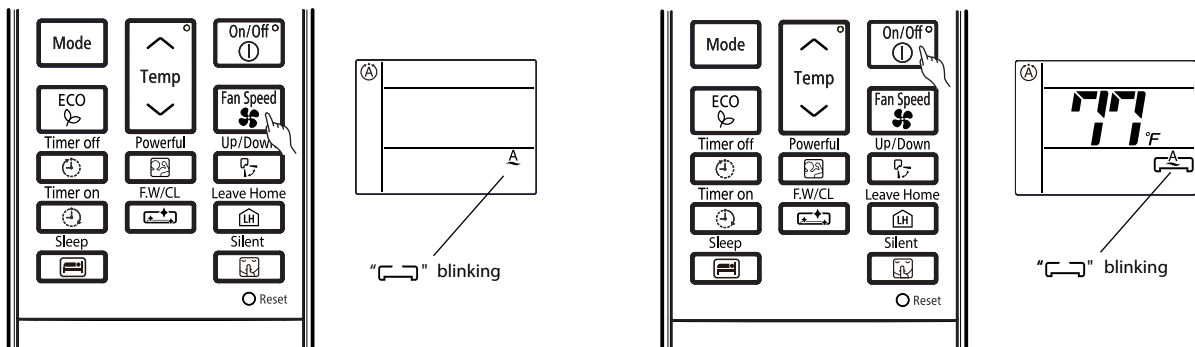

NOTE :

- (1) During "DISPLAY OPERATION MODE" "" blinks on LCD of remote controller.
- (2) When operation stops, "DISPLAY OPERATION MODE" is canceled.

Diagnosis and troubleshooting of indoor electric parts, outdoor electric parts and refrigerating cycle

Initiating troubleshooting

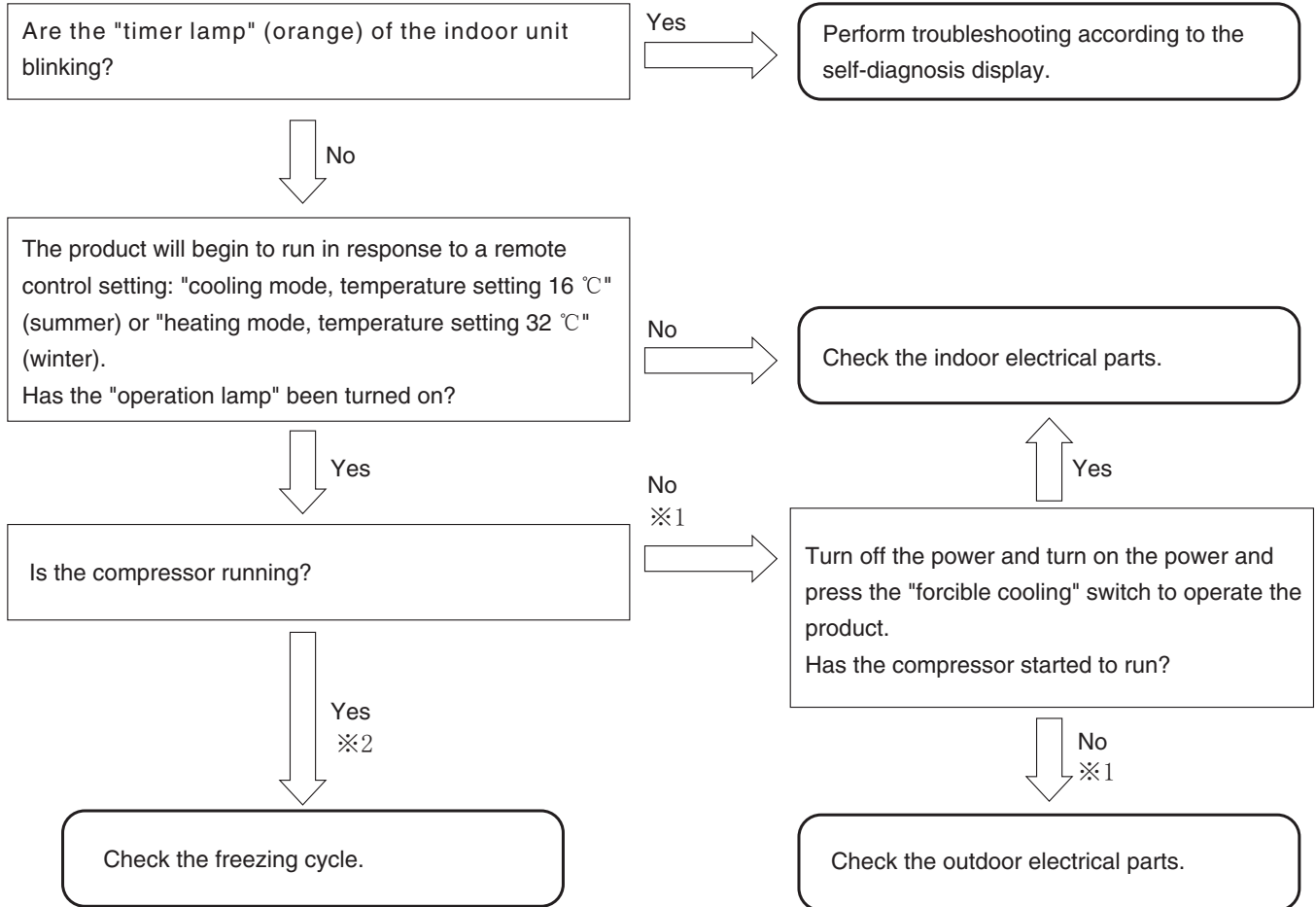

< Troubleshooting by using the self-diagnosis memory function >

- By using the self-diagnosis memory function, you can check the failure mode (※1) occurring in the outdoor electrical parts on the indoor unit side.

- Steps
1. Clear the troubleshooting data.
 2. Run the product for several minutes under the conditions where the compressor runs.
 3. Redisplay and check the data written in the self-diagnosis memory.

- The self-diagnosis memory function can also be used to catch sporadic failure phenomena.

- Steps
1. Clear the troubleshooting data.
 2. Have the user use the product as usual until a failure phenomenon occurs.
(The period depends on the incidence of the phenomenon.)
 3. At a later date, redisplay and check the data written in the self-diagnosis memory.

- For the outdoor self-diagnosis display (OH thermistor heat-up, overload lower limit cut) stemming from the freezing cycle or operating condition, the time lag is long from operation startup to the emergence of the phenomenon. Moreover, it is affected by the temperature, sunshine, operating hours, and other factors of the day, so that the phenomenon may not be able to be identified at the time of a repair service visit. In that case too, use the self-diagnosis memory function (※2).
- The outdoor self-diagnosis display "overload lower limit cut" and "OH thermistor heat-up" can be identified only when you are using the self-diagnosis lamp of the outdoor unit and the self-diagnosis memory function of the indoor unit. Note that this will not be automatically displayed on the indoor unit side.

Checking the indoor unit electrical parts

Introduction

First check the failure phenomenon and status, and then move on to elaborate diagnosis.

Initiating troubleshooting

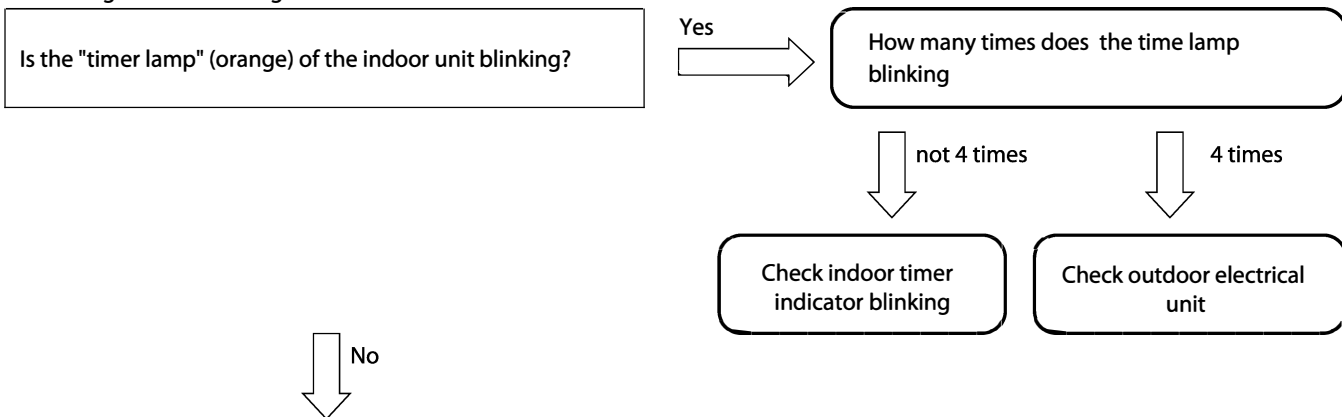

Turn off the power, wait at least 5 seconds, turn it back on, and observe the way the horizontal vanes move for about 30 seconds.
Check 1: Have the horizontal vanes moved? (Yes/No)

Set the remote control unit to cooling mode, temperature setting 16 °C and operate the product.

Check 2: Has the product received the remote control signal and has the "operation lamp" gone on? (Yes/No)

If you responded "Yes" to Check 2:
Check 3: Is the compressor of the outdoor unit running? (Yes/No)

If you responded "No" to Check 2:
Check 4: Does the "Temporary operation switch" work? (Yes/No)

Check results and next check items

Check 1	Check 2	Check 3	Check 4	Next check item
No	No	—	No	Go to "The power does not turn on".
Yes	No	—	Yes	Go to "The unit does not receive signals from the remote controller".
Yes	Yes	No	—	Go to outdoor side to check failure. Please refer diagnosis table for further checking if outdoor show fault.

1. Failure phenomenon: The power will not become turned on.

[Situation] Neither initialization, remote control, nor any other step works on the vane position at power-on.

- [Estimated failure locations]
- 3.15 A fuse blown out
 - Control power circuit
 - Connector loose, wire break

Estimated cause of fuse blowout

- Abnormally high voltage applied to the power supply
- Indoor fan motor out of order
- Power circuit out of order

- [Cautions]
- Before work, check the power supply voltage. An abnormal voltage may be being supplied in some rare occasions due to a defect in the indoor wiring (a wire break in the neutral wire of the single-phase 3-wire power supply).
 - If the 3.15 A fuse has blown out, eliminate the cause of the fuse blowout. Otherwise, there will occur another fuse blowout.
 - If the 3.15 A fuse has blown out due to an abnormally high voltage to the power supply, the varistor (VA001) will deteriorate and become destroyed as well.
 - On a repair service visit due to the failure phenomenon of "The power will not become turned on", take a "3.15 A fuse" and a "varistor" with you.

[Diagnosis flow]

Initiating troubleshooting

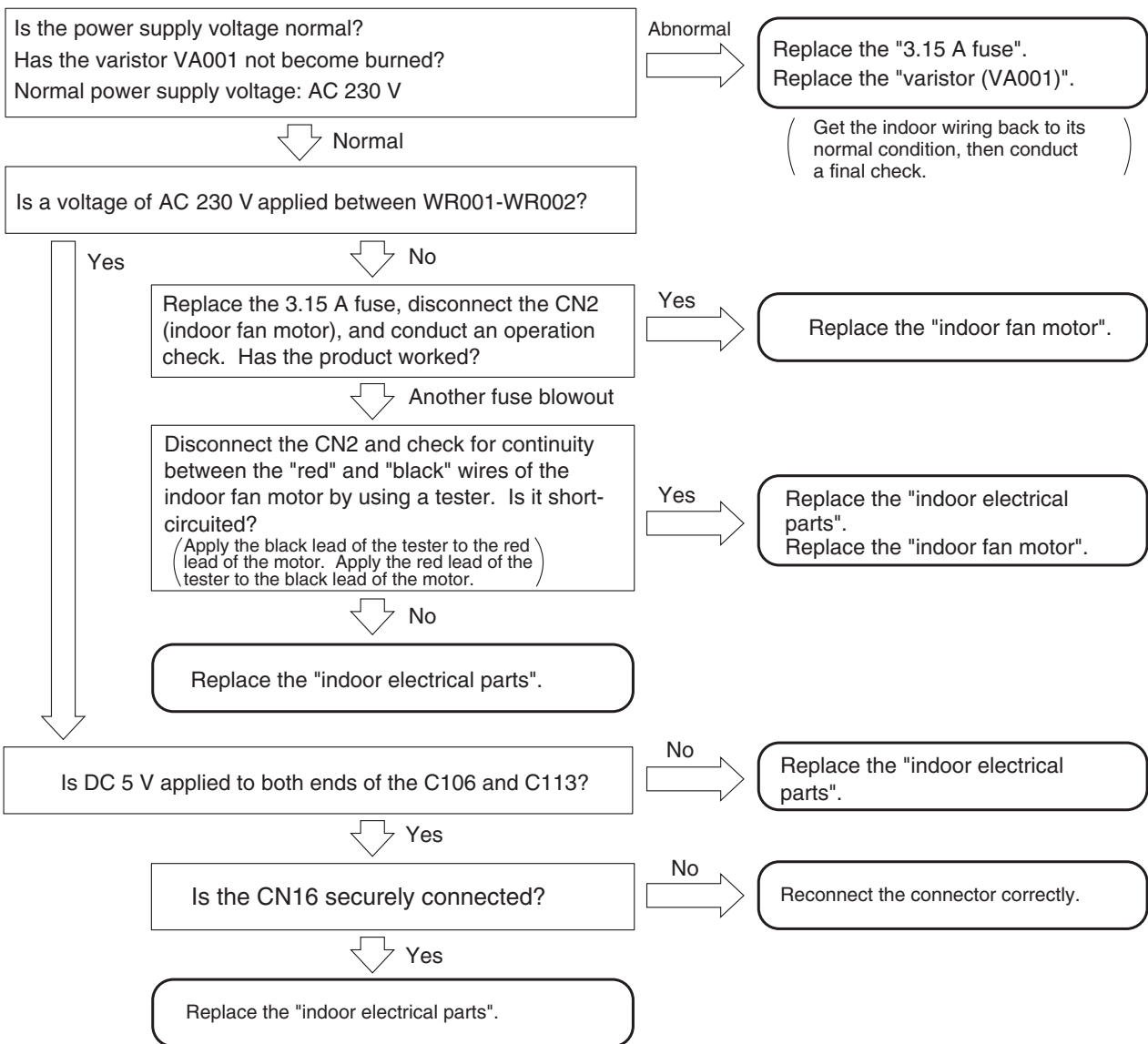

2.Failure phenomenon: The product will not receive a remote control signal.

- [Situation] The product does not receive a remote control signal. It is not very responsive.
(The product does run normally in response to the emergency operation switch.)
- [Estimated failure locations]
- Remote control failure, remote control low battery level, remote control poorly set
 - Remote control light-receiving unit
 - Connector loose, wire break
 - Normal product (external factors: the remote control units for lighting equipment and other equipment, electrical noise, etc.)
- [Cautions]
- Even if the product is trouble-free, a factor coming from outside the product may hamper the reception of signals from the remote control unit.
 - Batteries may decline in capacity at low temperatures. Old batteries decline particularly much in voltage in the morning and evening of winter, resulting in the poor arrival of remote control signals. Instruct your users to use new alkaline batteries.

[Diagnosis flow]

Initiating troubleshooting

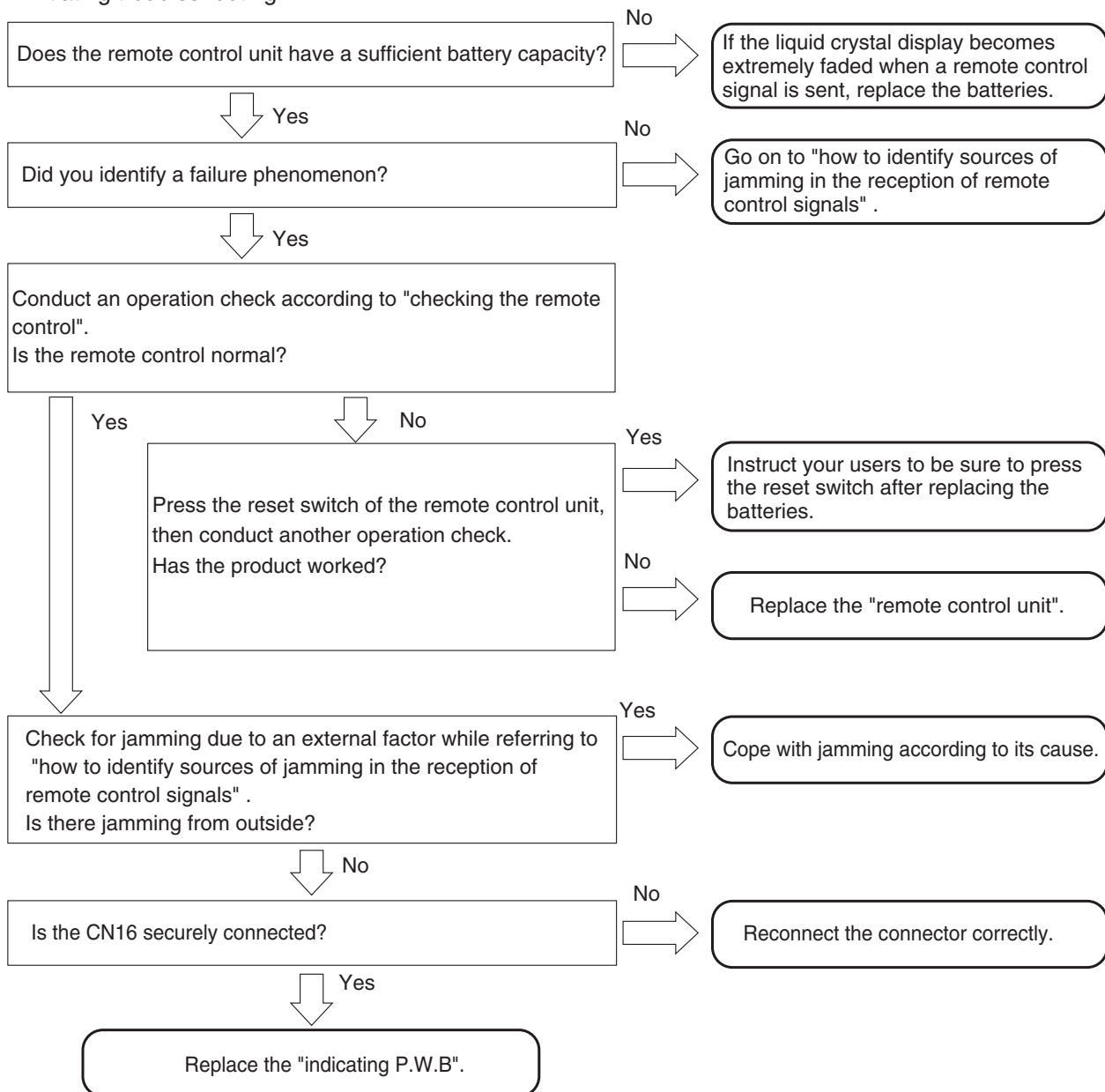

[Cautions in replacing the indicating P.W.B] Be sure to replace the indicating P.W.B. components.

How to identify sources of jamming in the reception of remote control signals

[Situation] The product may become poorly responsive to remote control signals due to external factors even though the product itself is trouble-free.

[Estimating sources of jamming] Identify the installation status of the air-conditioner and the indoor and outdoor environments to identify possible causes of the jamming.

- Indoor lighting equipment (quantity, type, location)
- Remote control units of other electrical products and equipment
- Is the grounding for the air-conditioner shared with other equipment?
- Are the surroundings of the air-conditioner clear of wireless antenna?
- Is the remote control light-receiving unit protected from direct sunlight?

[Checking and actions]

<p>Effects of lighting equipment (fluorescent lamps)</p>	<p><u>Checking points</u></p> <ul style="list-style-type: none"> · Turn on and off the lighting equipment and check for its effects on the reception of remote control signals. · When cold, the fluorescent lamp tends to emit infrared rays with wavelengths close to those used in remote control. <p>If you cannot detect the phenomenon about which your user is complaining at the time of your visit, such as "the product sometimes fails to receive remote control signals" and "the product fails to receive remote control signals in the morning alone", then turn off the lighting for about 20-30 minutes and wait for the fluorescent lamps to cool down before conducting another check.</p> <p>There are even cases where the product fails to receive remote control signals for 1 to 2 minutes only after the lighting equipment is turned on.</p> <ul style="list-style-type: none"> · The noise status may vary with the dimming of the lighting equipment. In the case of lighting equipment with a dimmer, therefore, conduct a check with all the light intensities. · If the lighting equipment is the source of the jamming, the remote control light-receiving unit output usually shows a noise waveform as shown in the right-hand figure. In the case of slight jamming, this kind of waveform will not cause practical problems. However, intense degrees of jamming will disable the reception of remote control signals. · When the fluorescent lamp is old and is flickering, it may cause disorders in the reception of remote control signals. <p><u>Actions proposed</u></p> <ol style="list-style-type: none"> 1. Make it hard for light of the lighting equipment to enter the remote control light-receiving unit. <ul style="list-style-type: none"> · Separate the lighting equipment from the indoor unit. · Raise the lighting equipment. · Cover the upper half of the light-receiving panel from its rear side with aluminum tape or black vinyl tape. <p>(This will also affect the reception of remote control signals. Therefore, set the range to be covered with tape to a range that is problem-free in practice, while checking the reception status.)</p> 2. Add an interference filter to the front panel of the remote control light-receiving unit. <ul style="list-style-type: none"> ※ Lighting equipment that produces strong jamming exists although rarely. Some problems may therefore be unsolvable by managing the air-conditioner side alone.
<p>Effects of the remote control units of other equipment</p>	<p><u>Checking points</u></p> <ul style="list-style-type: none"> · If, on the remote control unit of a TV or audio equipment, its sound volume key or something similar is left pressed, infrared signals become continuously sent, thereby jamming the reception of remote control signals. · Check how the remote control unit and related components are stored, thereby checking if there is any possibility that a button may be inadvertently left pressed on the remote control unit of other equipment. <p><u>Actions proposed</u></p> <p>If there is any such possibility, give explanations to your users to that effect and instruct them to exercise caution.</p>

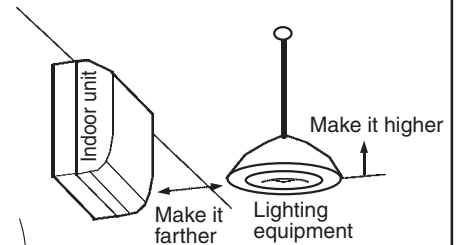
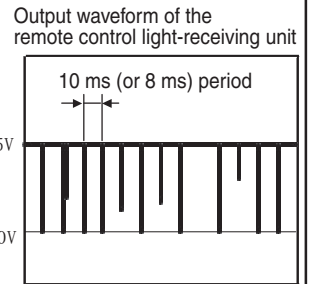

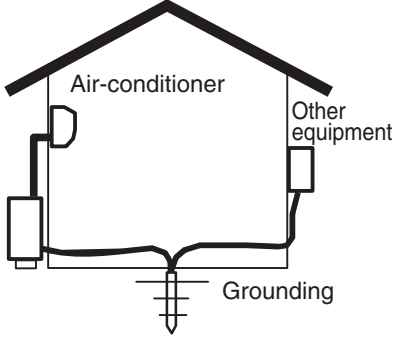
<p>Effects of other electrical products</p>	<p><u>Checking points</u></p> <ul style="list-style-type: none"> · Check the effects of light and power noises coming from other electrical products. · Turn on and off the electrical products, turn off the power and turn on the power, and check their effects on the reception of remote control signals. · For products whose operating states change, check the effects of each state. <p><u>Actions proposed</u></p> <ul style="list-style-type: none"> · Change the location relationship between the air-conditioner and the target products. · Use a different wall outlet for the target products.
<p>Sharing a grounding</p>	<p><u>Checking points</u></p> <ul style="list-style-type: none"> · Check for effects of electrical noises coming into the air-conditioner through grounding wires. · Check if the grounding works is for the air-conditioner alone or shared with other equipment. If there is any equipment that shares it, turn on and off that equipment and detach and reattach the power plugs and examine their effects on the reception of remote control signals. <p><u>Actions proposed</u></p> <ul style="list-style-type: none"> · Establish an independent grounding for the air-conditioner.  <p>The diagram shows a cross-section of a house with a gabled roof. An 'Air-conditioner' is mounted on the left wall, and 'Other equipment' is on the right wall. Both are connected to a single horizontal line representing a shared grounding system. This line leads to a vertical line labeled 'Grounding' which is connected to a ground symbol (three horizontal lines of decreasing width) at the bottom center.</p>
<p>Effects of radio waves</p>	<p><u>Checking points</u></p> <ul style="list-style-type: none"> · Using a wireless transmitter near the air-conditioner may affect the reception of remote control signals. · Have your users try sending signals with a wireless transmitter and examine their effects on the reception of remote control signals. <p><u>Actions proposed</u></p> <ul style="list-style-type: none"> · Add a ferrite core to the power cord and F cable. · Add a ferrite core to the internal wiring of the indoor unit. · Move the wireless antenna.
<p>Effects of direct sunlight</p>	<p><u>Checking points</u></p> <ul style="list-style-type: none"> · Direct sunlight and other intense light make the remote control light-receiving unit less sensitive. · Check for any time zone where the remote control light-receiving unit of the indoor unit is affected by direct sunlight depending on the location of the sun and mirror reflection. <p><u>Actions proposed</u></p> <ul style="list-style-type: none"> · Block the sunlight to protect against direct sunlight.

3. Failure phenomenon: The compressor will not run.

[Situation] The compressor will not run (the same state as the thermometer turned off), the product receives remote control signals normally. The self-diagnosis lamp (LD301) of the outdoor unit blinks once or becomes turned off.

[Estimated failure locations] · Room temperature thermistor, heat exchanger thermistor
· Microcomputer peripheral circuit

[Diagnosis flow]
Initiating troubleshooting

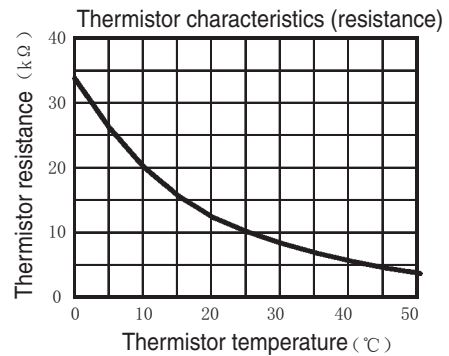
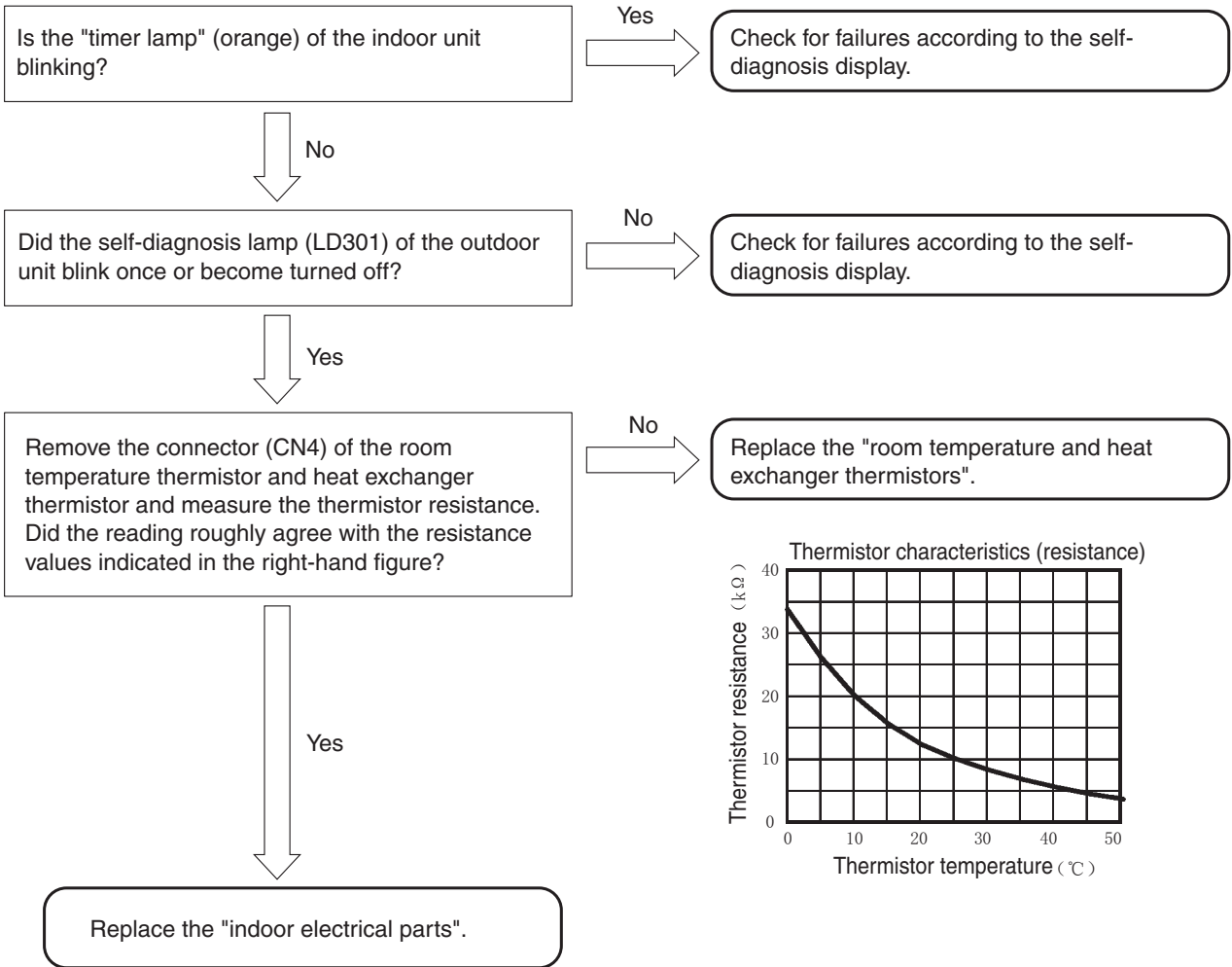

4. Failure phenomenon: The fan motor will not stop.

[Situation] I have conducted the stop operation on the product by remote control, but the indoor fan motor will not stop.
(It stopped about 10 minutes later.)

[Estimated failure locations]

- Indoor fan motor
- Fan motor drive circuit

[Diagnosis flow]

Initiating troubleshooting

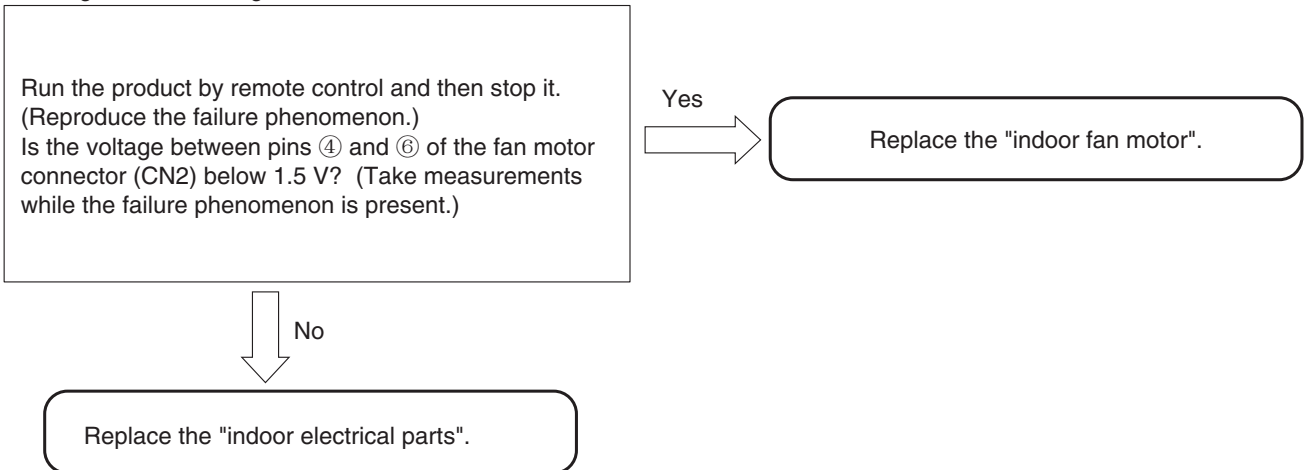

5. Timer lamp blinking: blinking once

[Situation] The timer lamp blinks one time and the product will not operate.
(This is not a sign of a breakdown.)

[Estimated failure locations] · Reversing valve defective.
· The refrigerating cycle block gas leak.

6. Timer lamp blinking: blinking twice

[Situation] The product is giving a display to indicate that it is performing forcible cooling.
(This is not a sign of a breakdown.)

7. Timer lamp blinking: blinking three times

[Situation] The timer lamp blinks three times and the product will not operate.

[Estimated failure locations] · Meltdown of the terminal board temperature fuse (the terminal board poorly inserted into the F cable)
· Outdoor communication circuit out of order

[Cautions] · If a terminal board is replaced to counter the meltdown of the terminal board temperature fuse, ensure that the F cable to be inserted into the terminal board has the appropriate dimension for peeling the insulation sheathing and that the insertion region is unbent before inserting it into the terminal board securely.

[Diagnosis flow]
Initiating troubleshooting

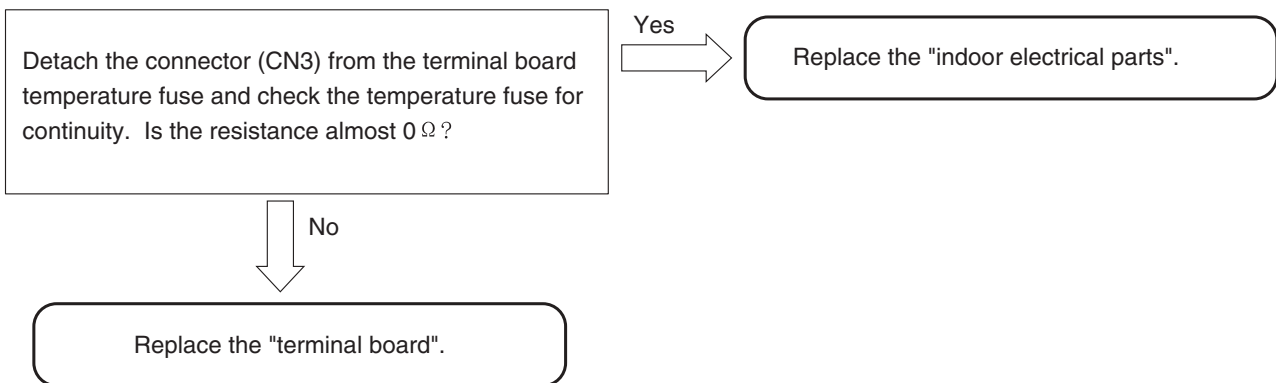

8. Timer lamp blinking: blinking four times

[Situation] The timer lamp blinks four times and the product will not operate.

[Estimated failure locations] · Outdoor unit error.
· Please confirm the times of the LD301 blinking, and then see the outdoor selfcheck table.

9. Timer lamp blinking: blinking 9 times

[Situation] The timer lamp blinks 9 times and the product will not run.

[Estimated failure location] • Loose connector, wire break, or short-circuit in the room temperature thermistor, heat exchanger thermistor.

[Cautions] • Starting the product by remote control will initiate failure detection.
(Merely turning on the power will not activate the failure detection function.)

[Diagnosis flow]

Initiating troubleshooting

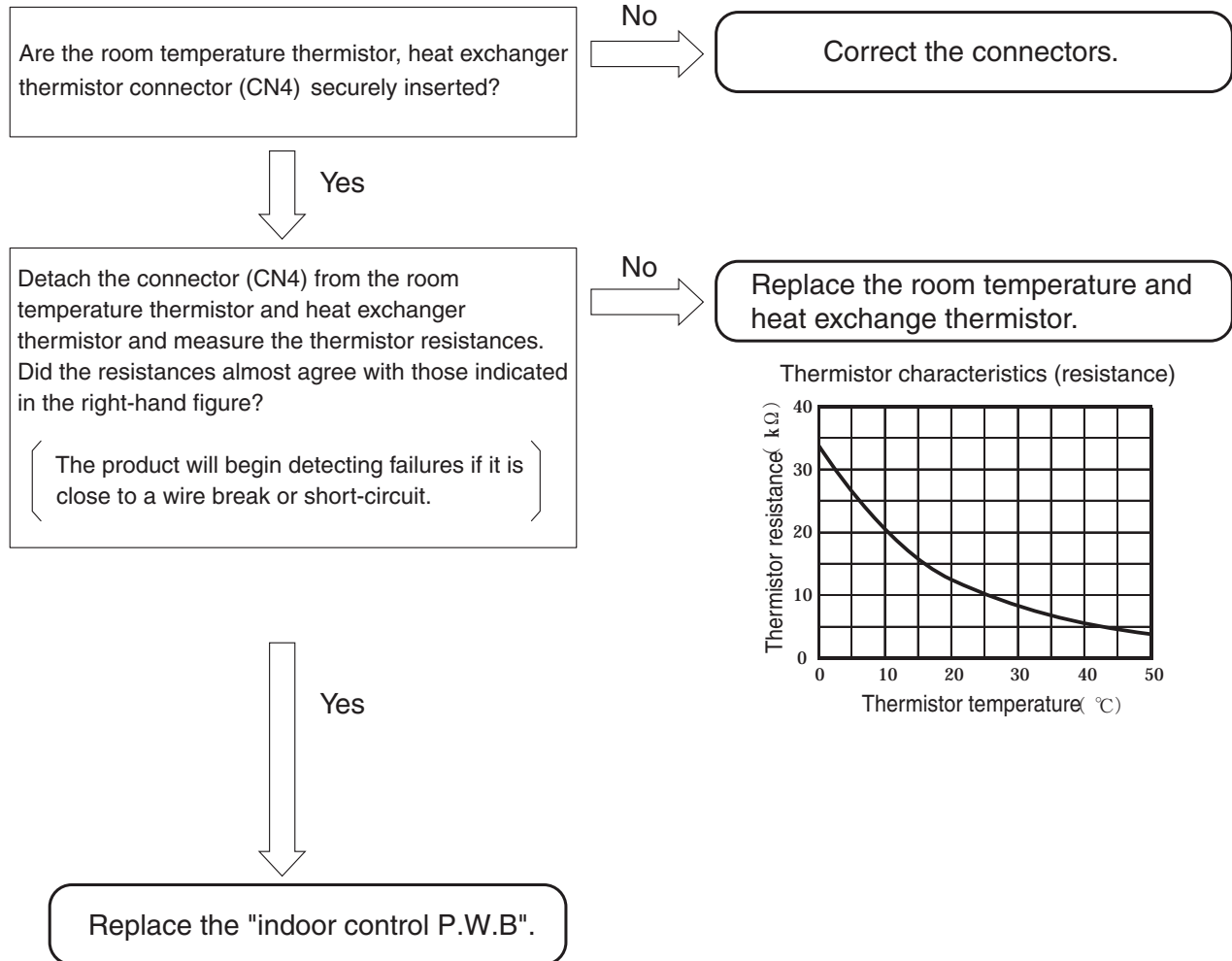

10. Timer lamp blinking: blinking 10 times

[Situation] The timer lamp blinks 10 times and the product will not run.

- [Estimated failure locations]
- Loose connector or wire break in the indoor fan motor
 - Indoor fan motor mechanically locked
 - Indoor fan motor
 - Indoor fan motor drive circuit

[Diagnosis flow]

Initiating troubleshooting

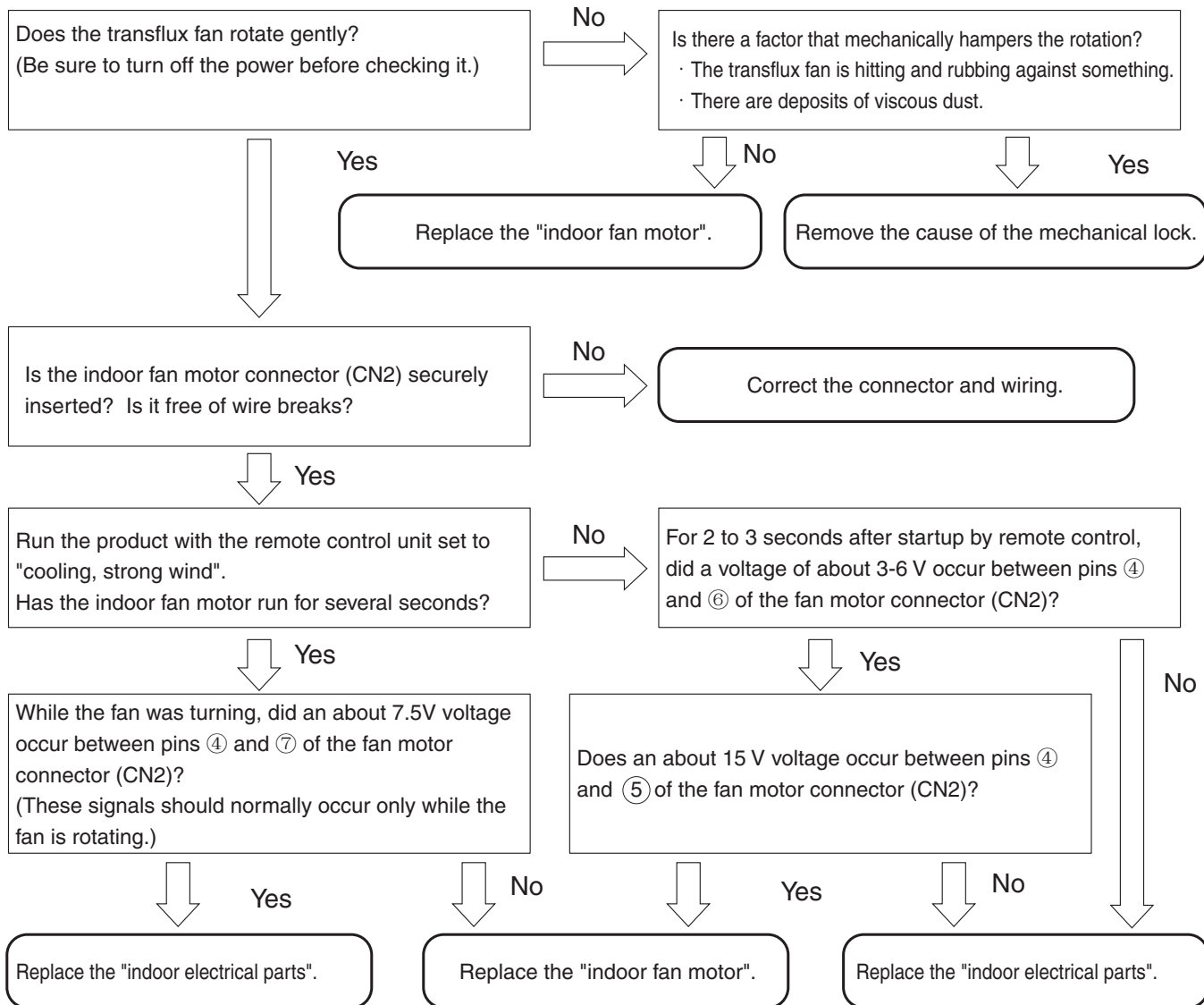

11. Timer lamp blinking: blinking 12 times

[Situation] The timer blinks 12 times and the product will not run.

- [Estimated failure locations]
- Erroneous connection in the indoor-outdoor connection line (F cable)
 - Forget to connect CN27 of outdoor P.W.B
 - Wire break or poor insertion of the indoor-outdoor connection line (F cable)
 - Electrical parts in the outdoor unit (communication circuit, power circuit error)
 - Communication error due to noise in other home electronics
 - ※This does not constitute a failure in the air-conditioner

[Cautions] • When lines 1 and 2 of F cable are erroneously connected (crossed), the product may not enter self-diagnosis display mode. If the self-diagnosis memory stores data about "timer lamp blinked 12 times", then, just in case, check if the F cable is not erroneously connected.

[Diagnosis flow]

Initiating troubleshooting

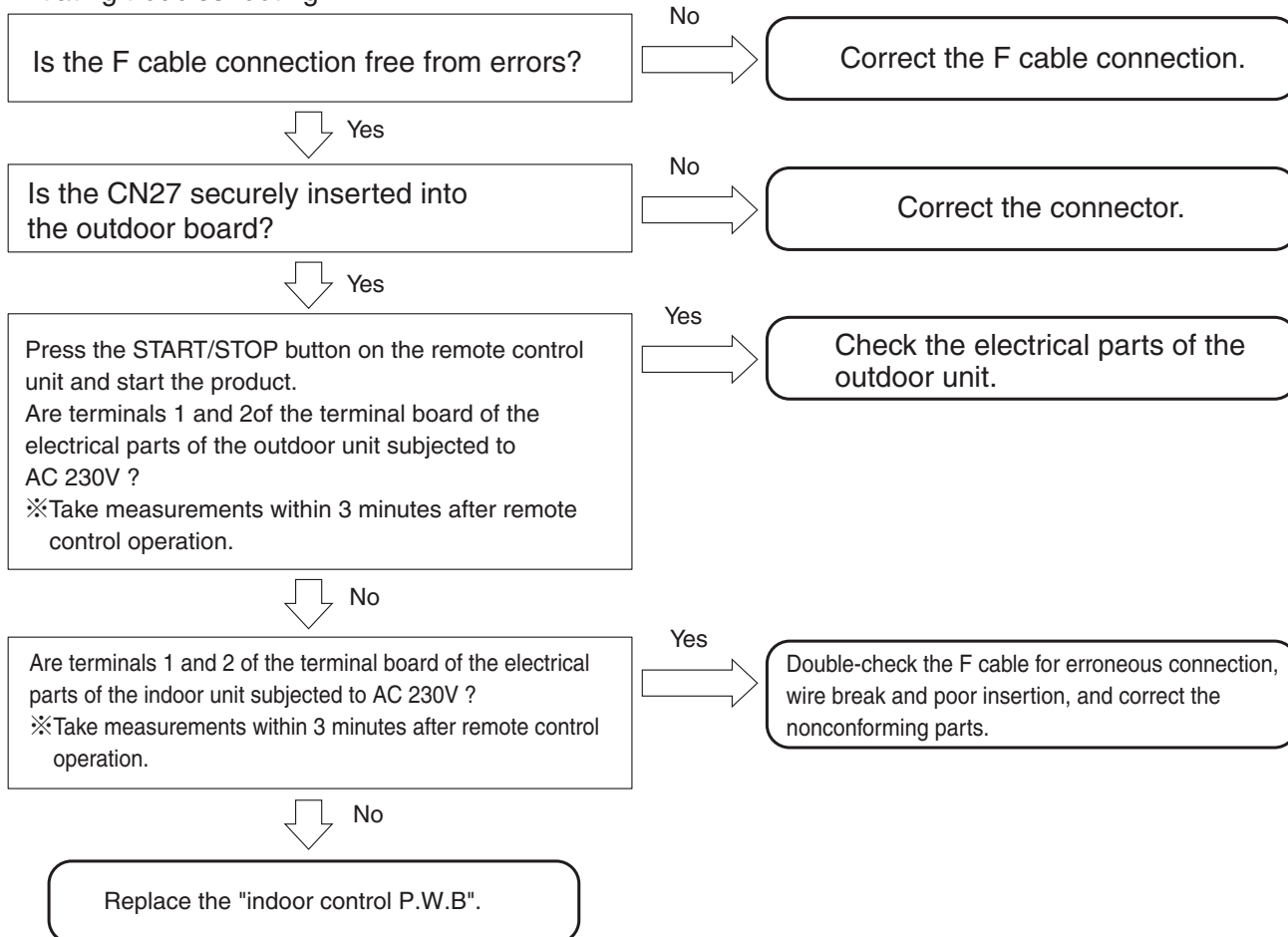

12. Timer lamp blinking: blinking 13 times

[Situation] The timer lamp blinks 13 times and the product will not run.

[Estimated failure location] • EEPROM, microcomputer

[Diagnosis flow]

Replace the "indoor control P.W.B".

Checking Electrical Parts of Outdoor Unit

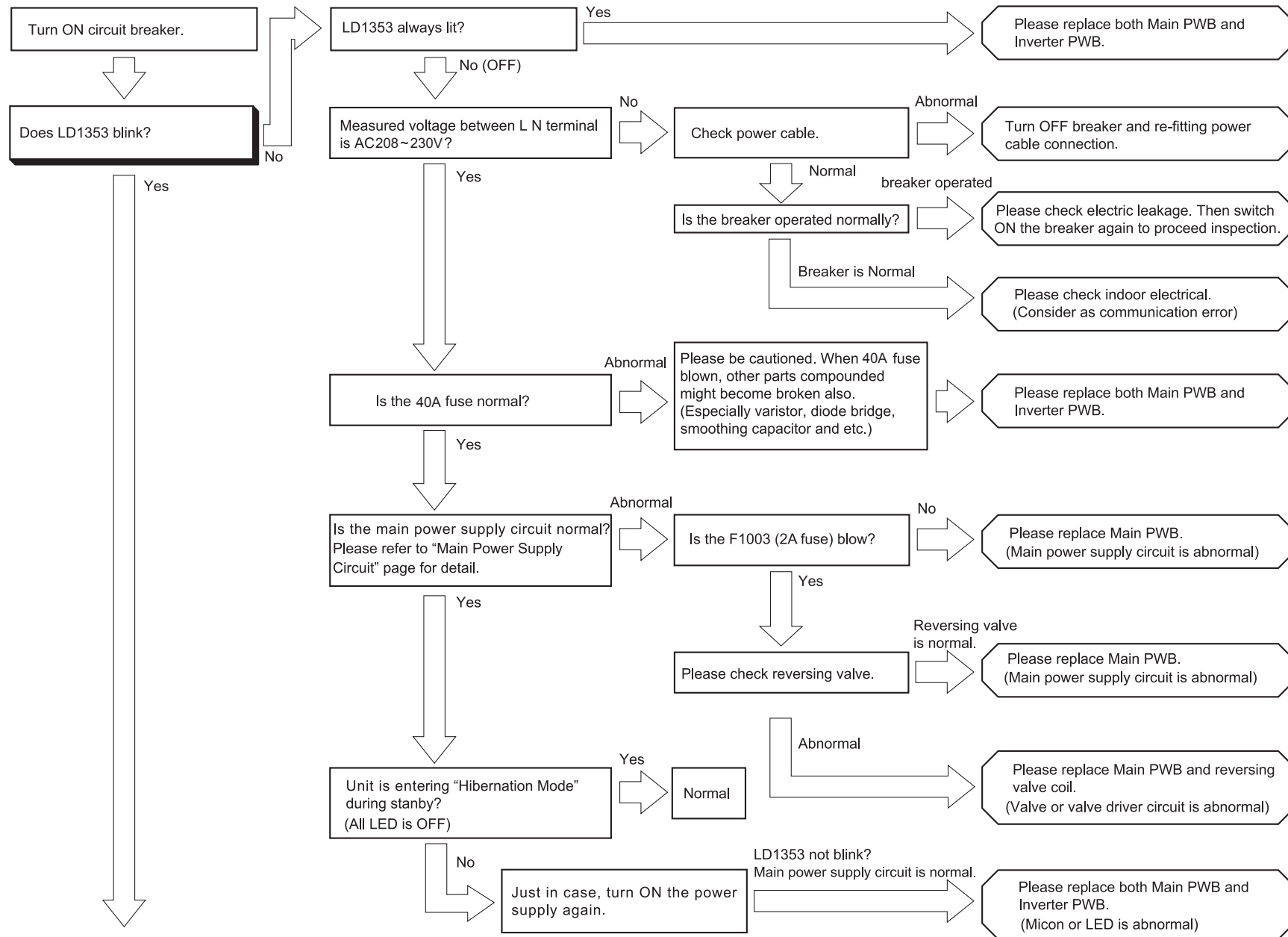

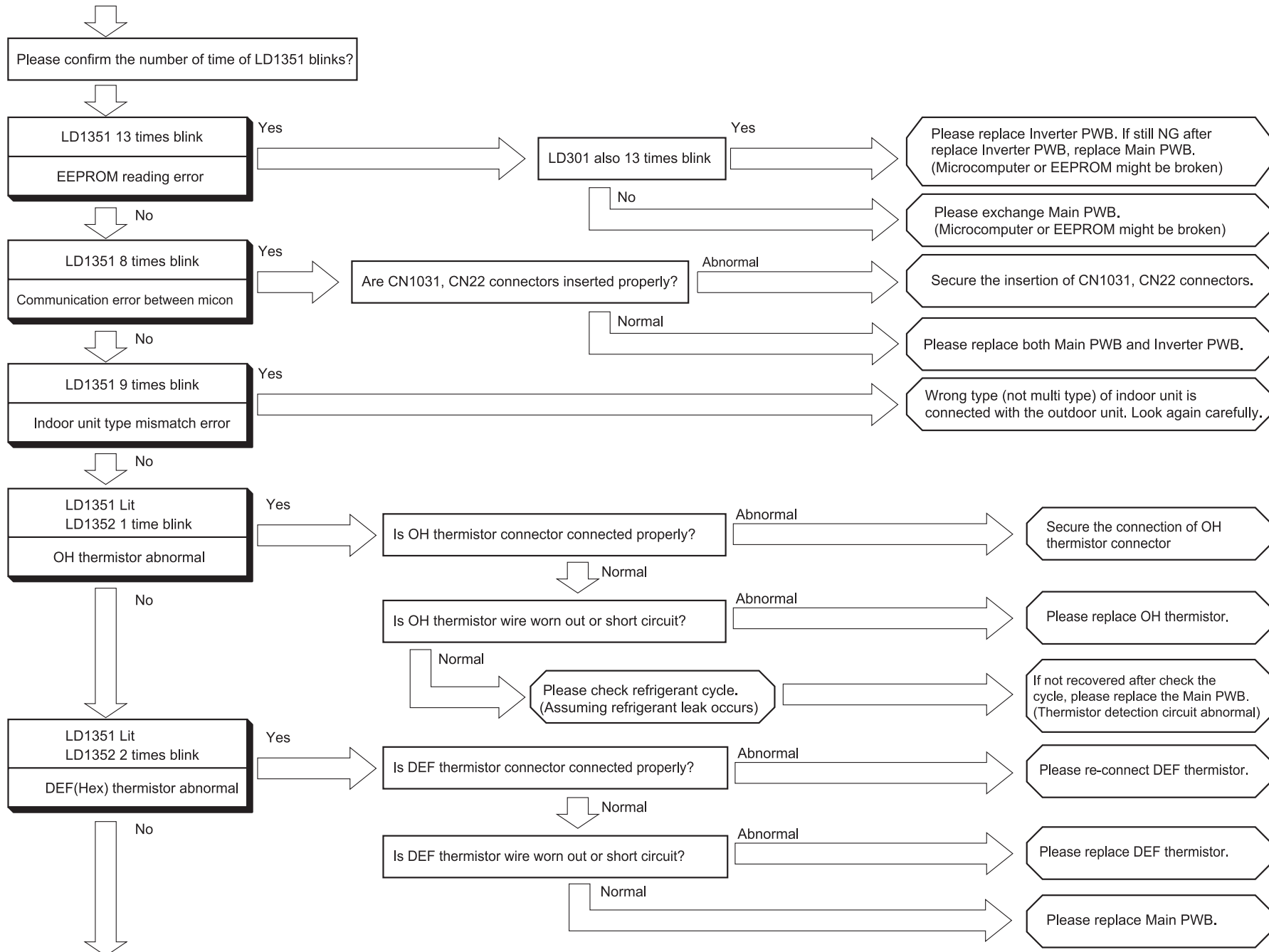

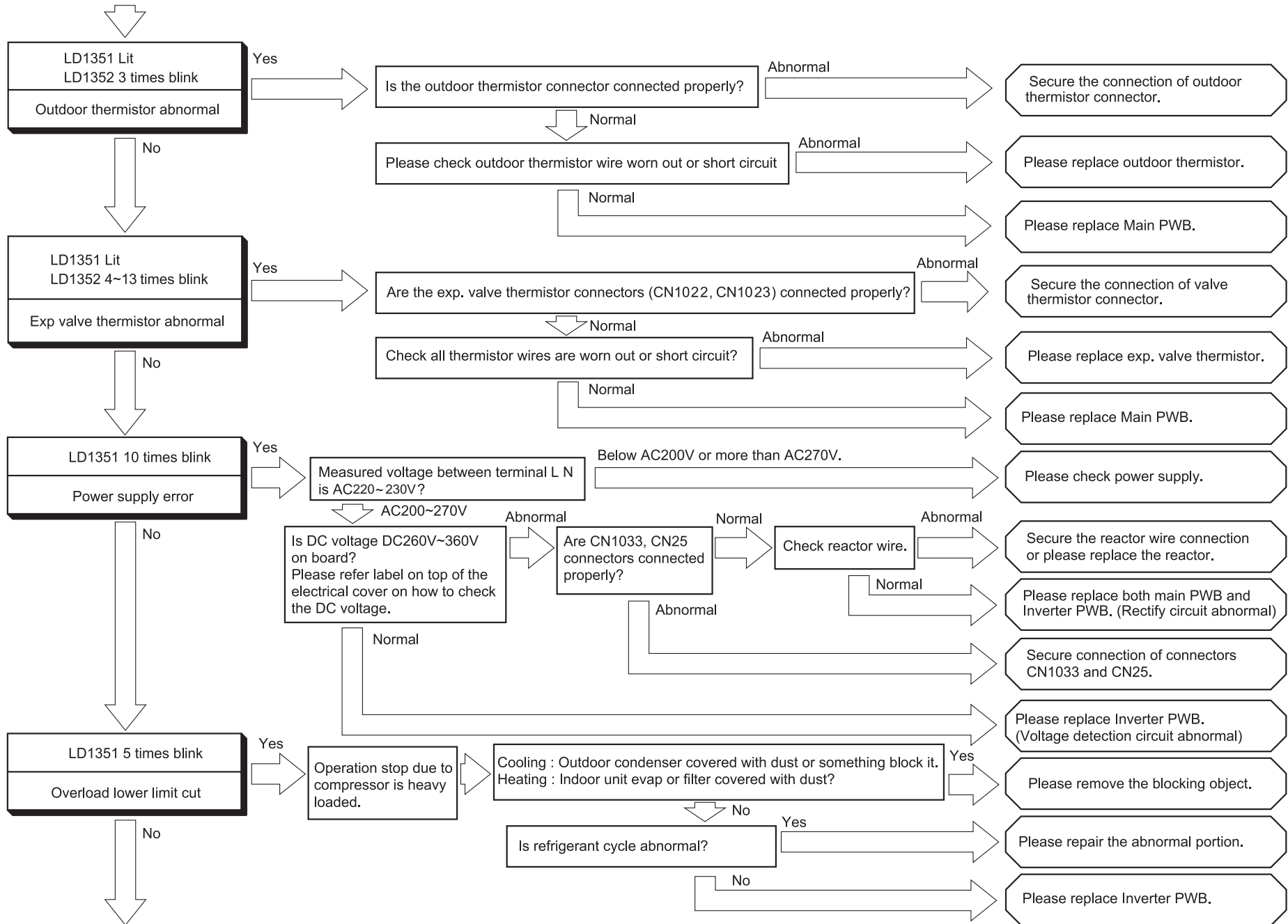

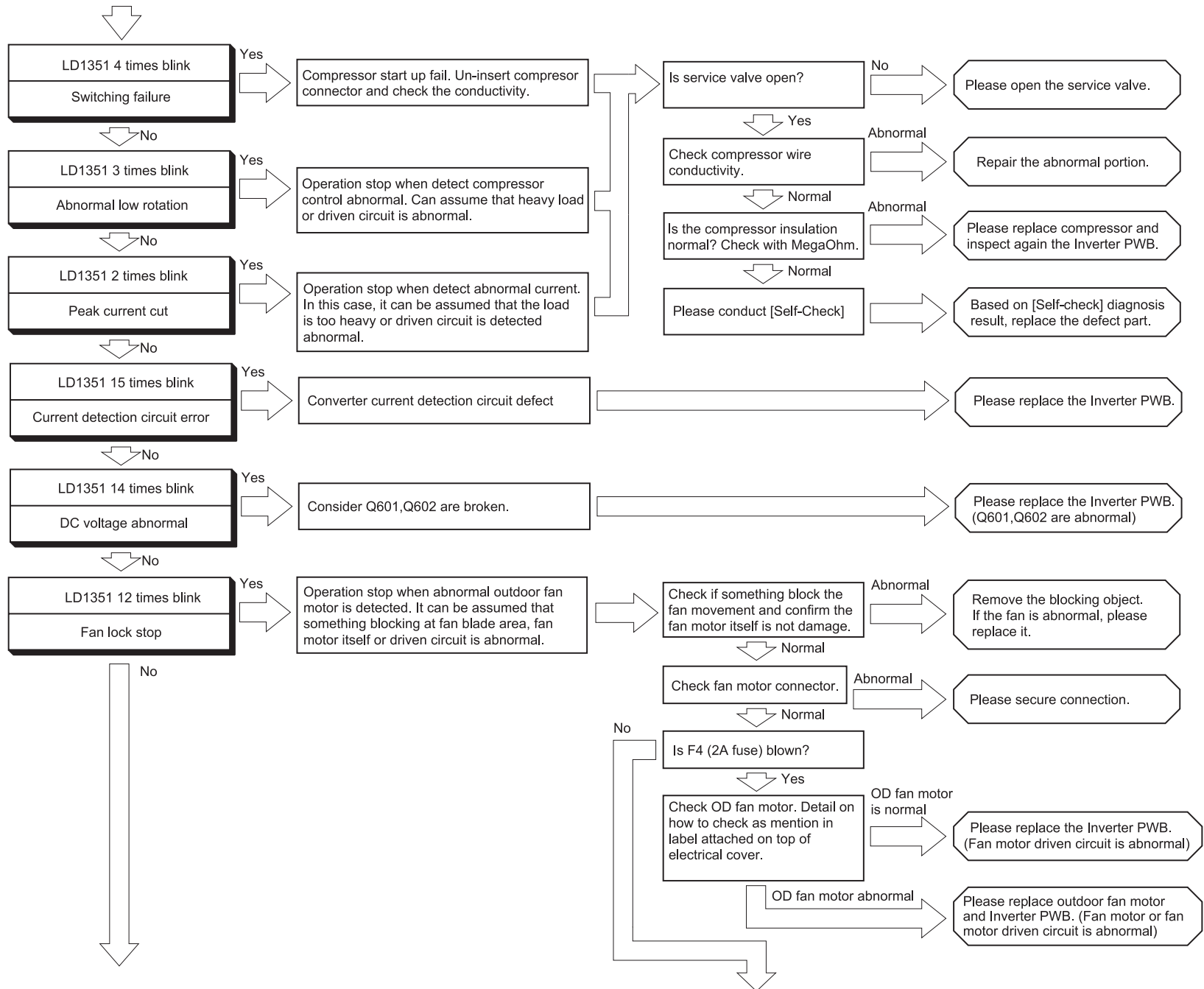

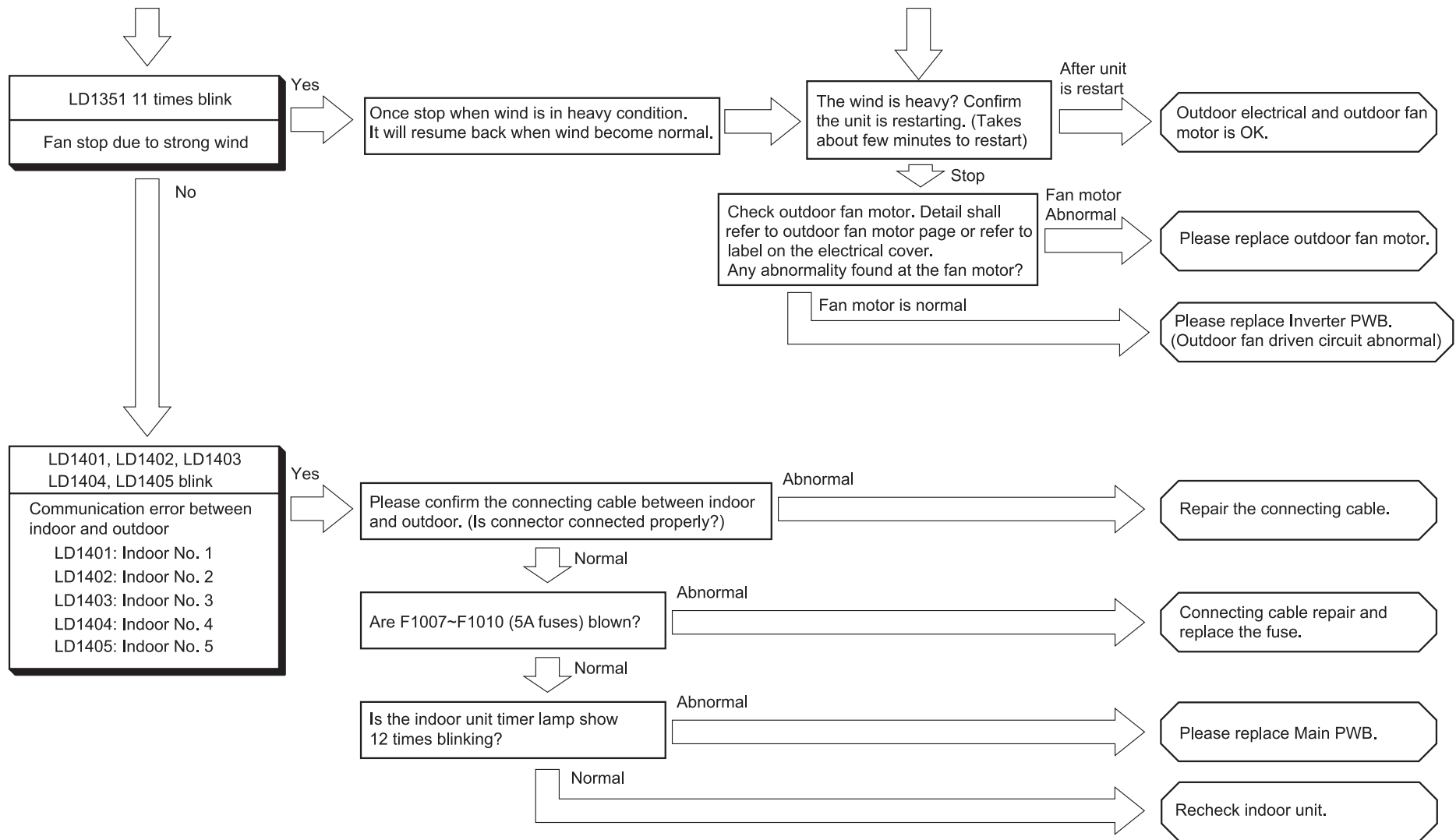

PARTS LIST AND DIAGRAM

INDOOR UNIT
MODEL : RAS-EH36PHL AE

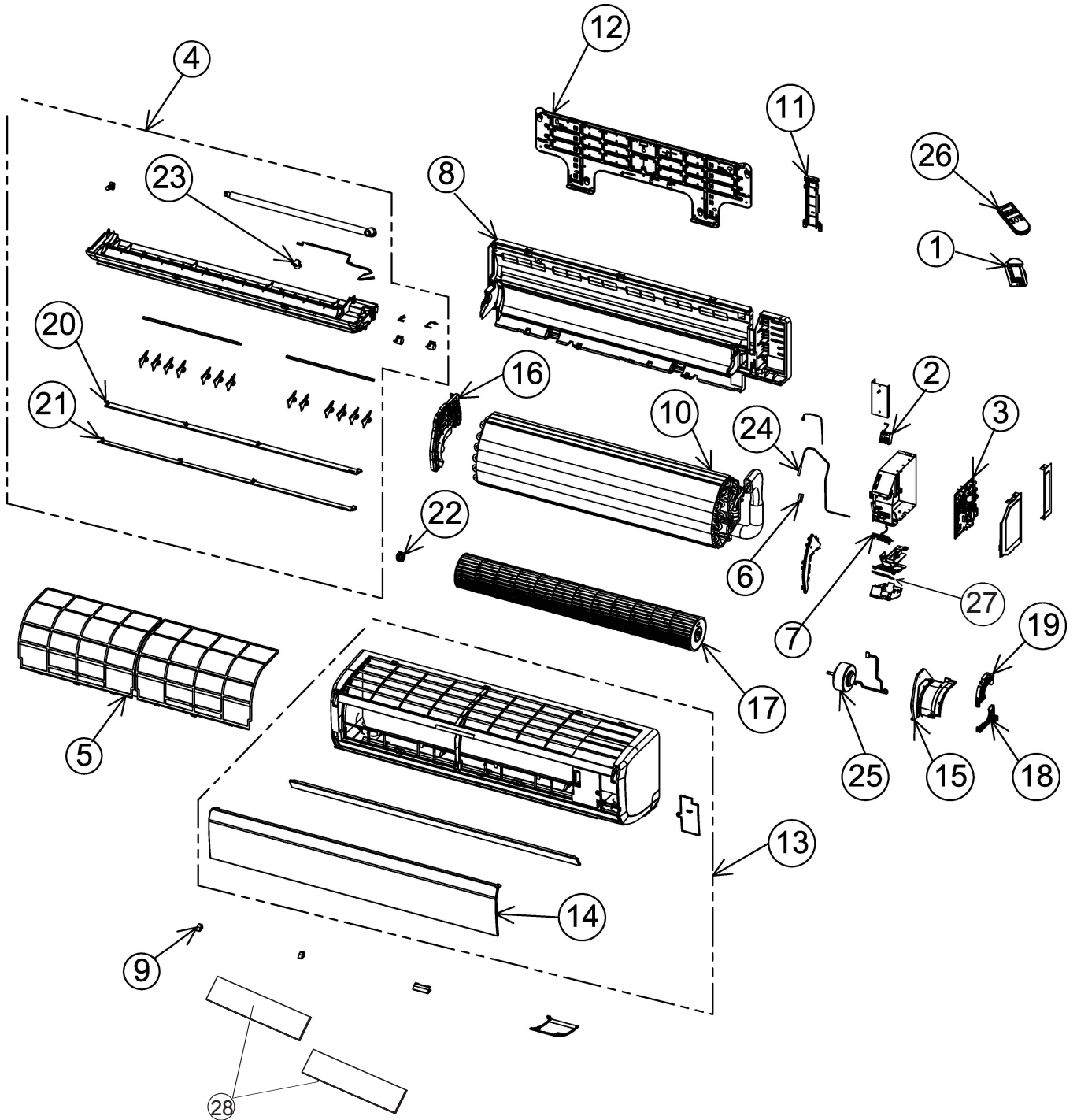

MODEL RAS-EH36PHLAE

NO.	PART NO.	Q'TY / UNIT	PARTS NAME
1	PMRAS-VX13CET R10	1	REMOTE CONTROL SUPPORT
2	PMRAK-50PPD R07	1	TERMINAL BOARD (3P)
3	PMS-EH36PHLAE R01	1	P.W.B (MAIN)
4	PMS-EH24RHLAE R02	1	DRAIN PAN ASSY
5	PMS-SH18RHLAE R03	2	FILTER
6	PMRAS-10C8M R03	1	THERMISTOR SUPPORT
7	PMRAS-S50YHAB R02	1	PWB RECEIVER
8	PMRAS-70YHA4 R04	1	CABINET
9	PMRAS-70YHA4 R05	1	CAP
10	PMRAS-70YHA4 R07	1	CYCLE ASSY
11	PMRAS-70YHA4 R08	1	PIPE SUPPORT
12	PMRAS-70YHA4 R09	1	MOUNTING PLATE
13	PMRAS-70YHA4 R10	1	FRONT COVER ASSY
14	PMRAS-70YHA4 R11	1	FRONT PANEL
15	PMRAS-70YHA4 R12	1	FAN MOTOR BASE
16	PMRAS-70YHA4 R13	1	BEARING COVER
17	PMRAS-X30HGT R02	1	TANGENTIAL FLOW FAN
18	PMRAS-70YHA4 R15	1	FAN MOTOR SUPP-RS
19	PMRAS-70YHA4 R16	1	FAN MOTOR SUPP-RU
20	PMRAS-70YHA4 R17	1	H-DEFLECT 1
21	PMRAS-70YHA4 R18	1	H-DEFLECT 2
22	PMRAS-25YH4 908	1	P-BEARING ASSY
23	PMRAS-72CHA3 R01	1	AUTO SWEEP MOTOR
24	PMRAS-XH10CKT R06	1	THERMISTOR
25	PMS-EH24RHLAE R04	1	FAN MOTOR
26	PMRAS-E25YCAB R01	1	REMOTE CONTROL
27	PMS-EH24RHLAE R03	1	MS-BOARD
28	SPX-CFH22AC25	2	ACL-FILTER

PARTS LIST AND DIAGRAM

OUTDOOR UNIT

MODEL: RAC-EH36HLAE

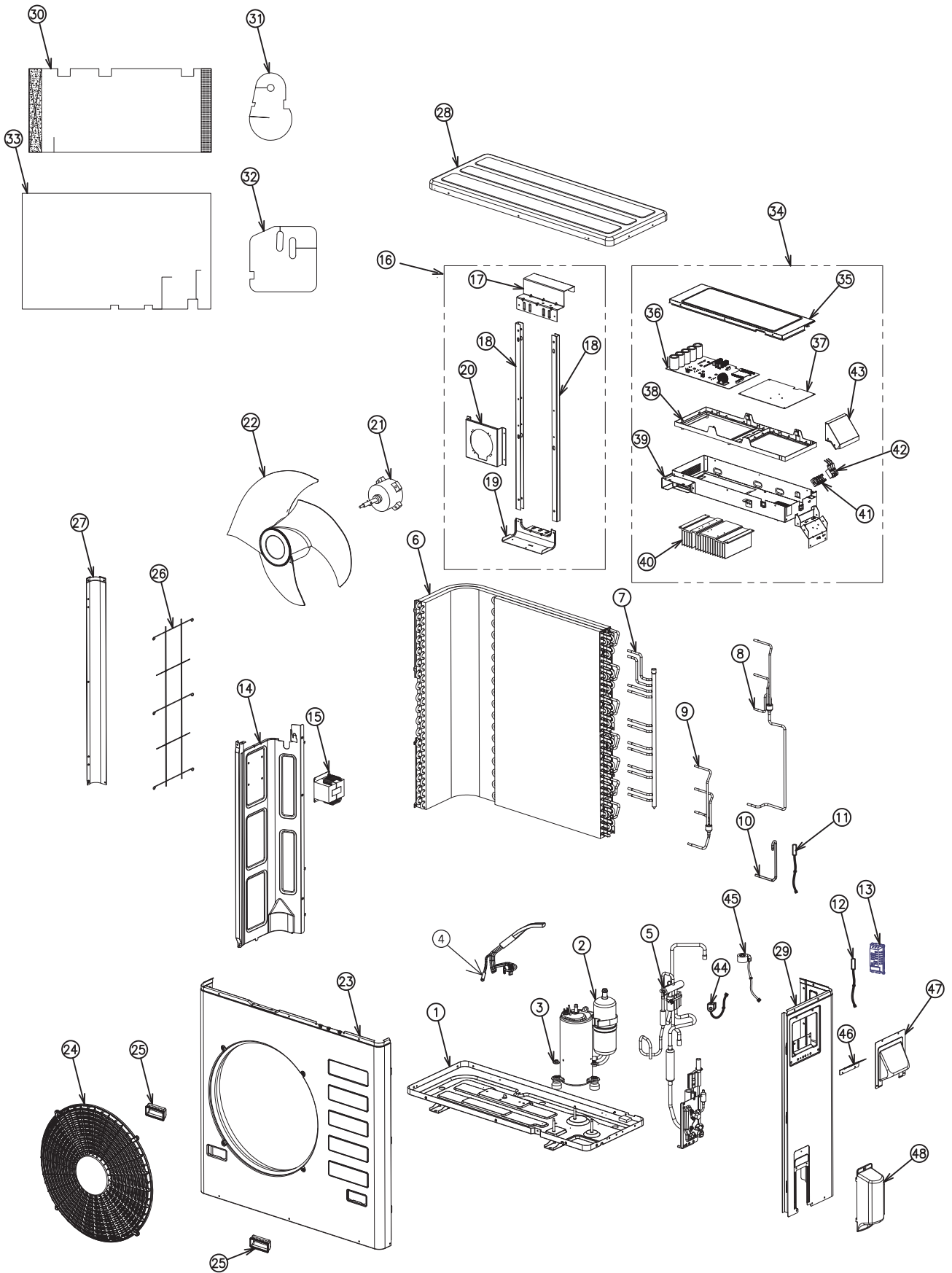

MODEL RAC-EH36WHLAE

No.	JCH-WH PARTS NO.	Q'TY/UNIT	PARTS NAME
1	HWRAC-EH36WHLAE A01	1	BASE AS
2	HWRAC-F112MVX 010	1	COMPRESSOR
3	HWRAM-110NP5E A04	3	COMPRESSOR NUT
4	HWRAC-EH36WHLAE A02	1	CONNECT CORD (COMP)
5	HWRAC-EH36WHLAE A03	1	4-REVERSING VALVE AS
6	HWRAC-EH36WHLAE A04	1	CONDENSER
7	HWRAC-EH36WHLAE A05	1	EI-PIPE-AS
8	HWRAC-EH36WHLAE A06	1	EO-PIPE-AS-1
9	HWRAC-EH36WHLAE A07	1	EO-PIPE-AS-2
10	HWRAC-EH36WHLAE A08	1	OUTLET PIPE
11	HWRAC-EH36WHLAE A09	1	TERMI-C
12	HWRAC-EH36WHLAE A10	1	TERMI-DEFROST
13	HWRAC-50WXDN A06	1	TERMI-COVER
14	HWRAC-F160MVX 006	1	BULK
15	HWRAC-F160MVX 005	1	REACTOR
16	HWRAC-F160MVX 041	1	BRACKET GP-MOTOR
17	HWRAC-F160MVX 018	1	FAN MOTOR SUPPORT
18	HWRAC-F160MVX 019	2	FAN MOTOR SUPPORT
19	HWRAC-F160MVX 020	1	FAN MOTOR SUPPORT
20	HWRAC-F86KVX 013	1	FAN MOTOR SUPPORT PLATE
21	HWRAC-F86KVX 018	1	FAN MOTOR
22	HWRAC-F86KVX 006	1	PROPELLER FAN
23	HWRAC-EH36WHLAE A11	1	FRONT COVER
24	HWRAM-110NP5E A36	1	DISCHARGE GRILL
25	HWRAC-X10CSK 103	2	HANDER
26	HWRAC-L72GVX 004	1	NET LEFT
27	HWRAC-F160MVX 022	1	LEFT PLATE
28	HWRAM-S42U5HLAE A08	1	TOP COVER
29	HWRAC-EH36WHLAE A12	1	RIGHT COVER
30	HWRAC-EH36WHLAE A13	1	SOUND PROOF
31	HWRAC-EH36WHLAE A14	1	SOUND PROOF
32	HWRAC-EH36WHLAE A15	1	SOUND PROOF
33	HWRAC-EH36WHLAE A16	1	SOUND PROOF
34	HWRAC-EH36WHLAE A17	1	ELECTRICAL BOX
35	HWRAC-F160MVX 032	1	ELECTRICAL PARTS COVER
36	HWRAC-EH36WHLAE A18	1	P.W.B (INVERTER)
37	HWRAC-EH36WHLAE A19	1	P.W.B (MAIN)
38	HWRAM-S42U5HLAE A17	1	SUPPORT (P.W.B)
39	HWRAC-EH36WHLAE A20	1	EXECTRICAL PLATE ASS
40	HWRAC-F160MVX 037	1	HEAT SINK
41	HWRAC-F160MVX 038	1	TERMINAL BOARD (3P)
42	HWRAC-1F50KVY 016	1	TERMINAL BOARD (3P)
43	HWRAC-F160MVX 040	1	TERMINAL COVER
44	HWRAC-EH36WHLAE A21	1	4 VALVE COIL
45	HWRAC-EH36WHLAE A22	1	EXV COIL
46	HWRAC-EH36WHLAE A23	1	CONDUIT PLATE
47	HWRAC-EH36WHLAE A24	1	TERMINAL COVER
48	HWRAC-F160MVX 025	1	SIDE COVER

HITACHI

RAS-EH36PHLAE / RAC-EH36WHLAE

PM NO.0753E

Printed in Malaysia